

Product Change Notice (PCN)

Date: 11/25/2019

PCN Number: PCN-0450260R-01

To Our Customers:

We appreciate your use of CUI Devices products. Our commitment in maintaining and improving processes is demonstrated by plans to enhance our product quality, reliability and manufacturability. The purpose of this notice is to inform you of a product change.

Product(s) Affected: MD-SM series (part numbers MD-30SM, MD-40SM, MD-50SM, MD-60SM, MD-70SM, MD-80SM, MD-90SM).

Reason(s) for Change: Manufacturing build location change.

Description of Change: minor dimensional changes, and material changes, as shown below.

Old Design (MD-30SM, MD-40SM, MD-50SM, MD-60SM, MD-70SM, MD-80SM)

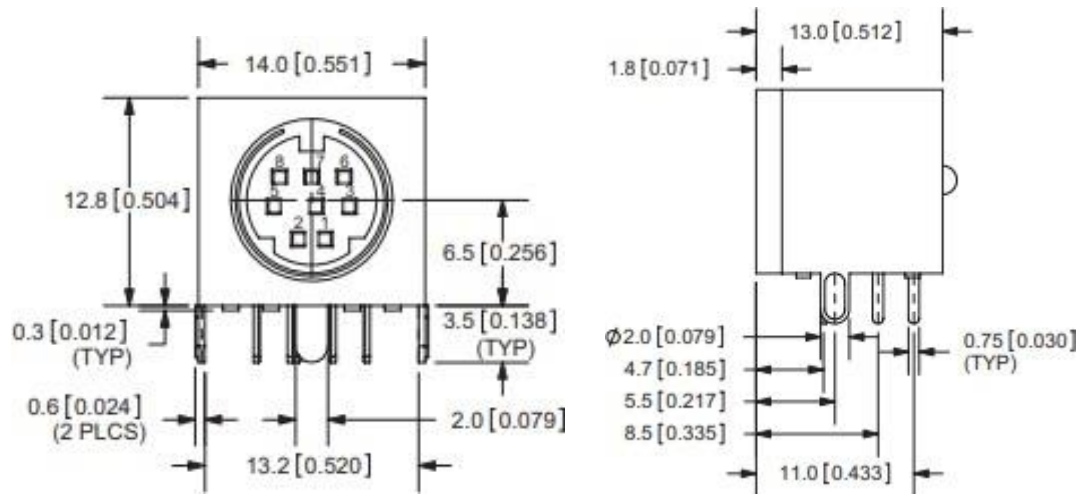

Old Design (MD-90SM)

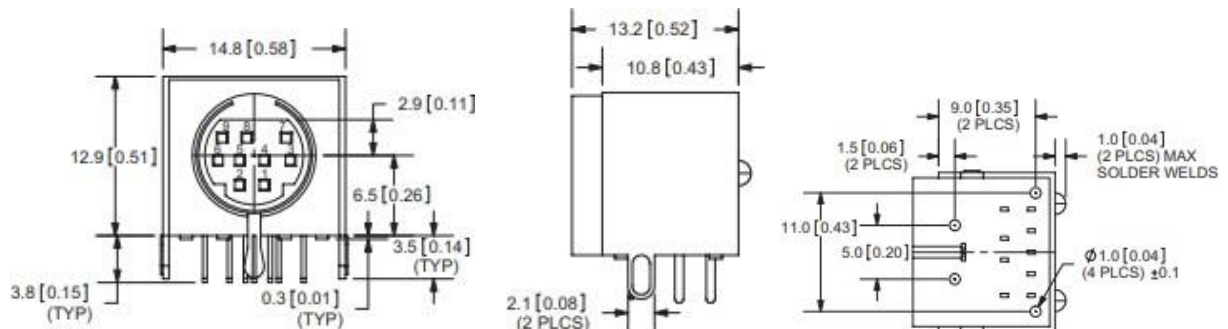

New Design (MD-30SM, MD-40SM, MD-50SM, MD-60SM, MD-70SM, MD-80SM)

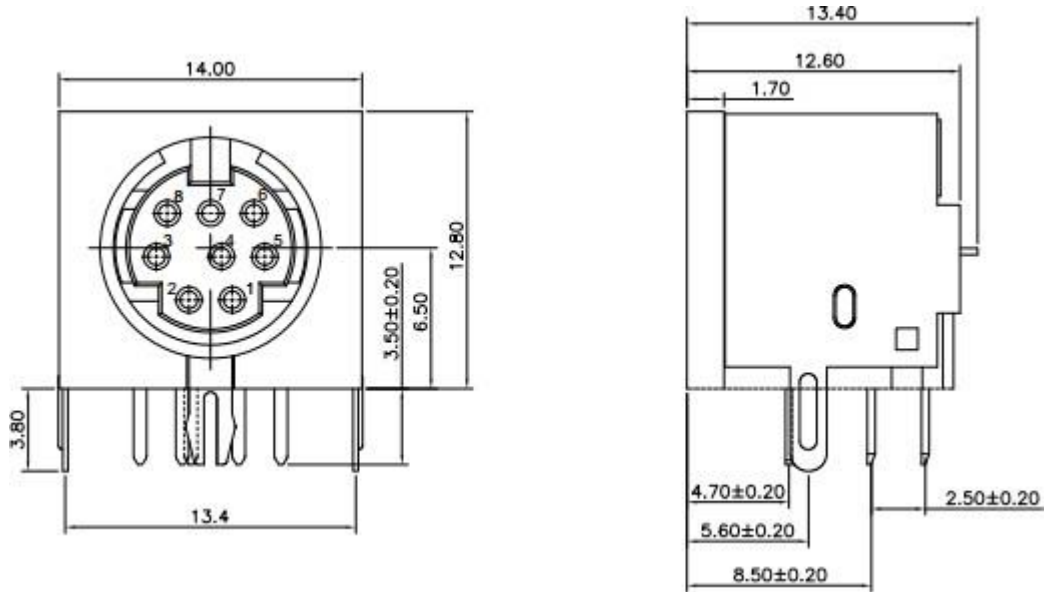

New Design (MD-90SM)

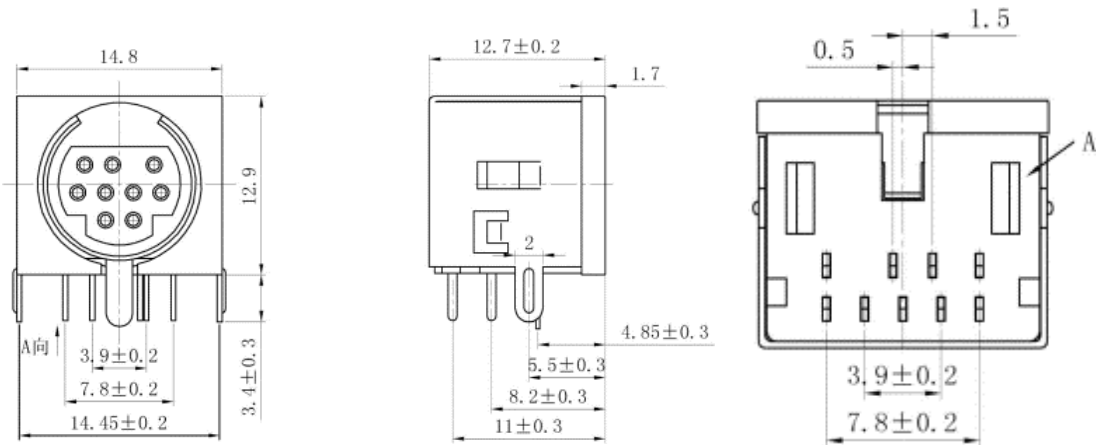

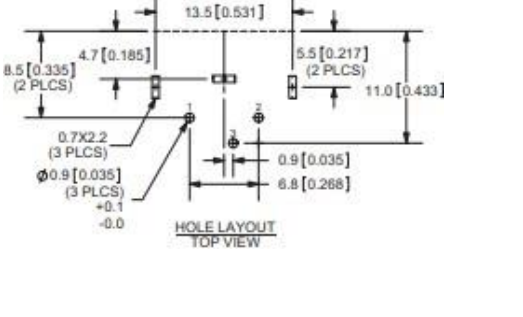
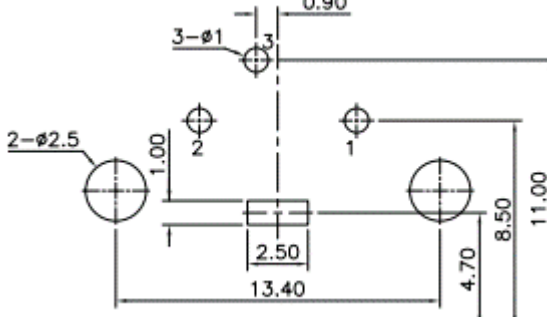
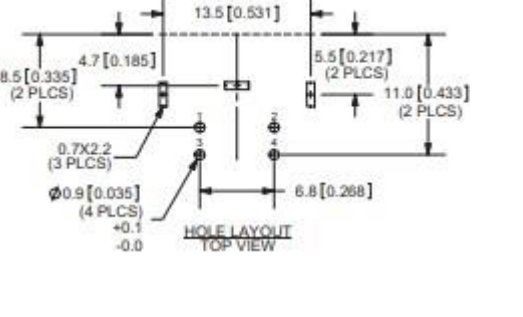
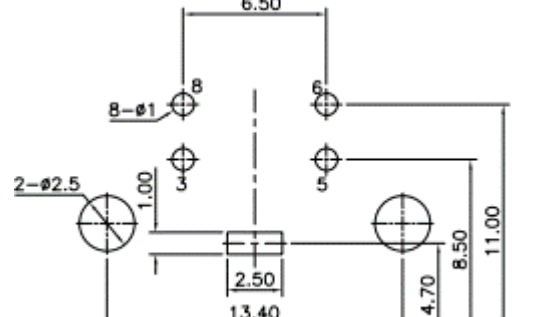
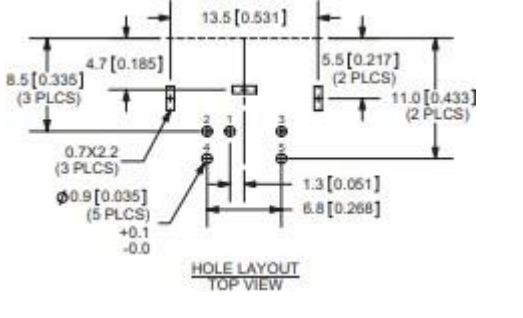
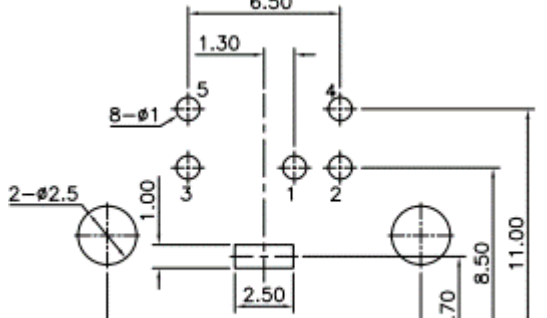
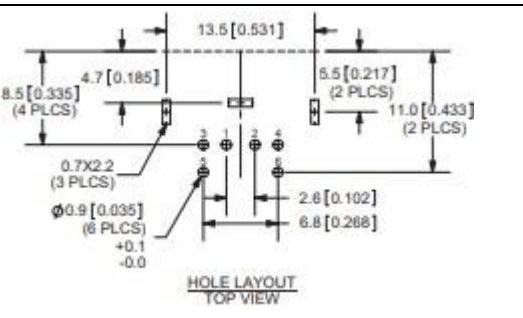
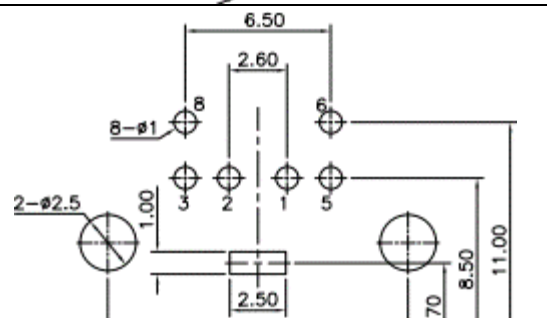
PCB Layout Old Design	PCB Layout New Design
 <p>HOLE LAYOUT TOP VIEW</p> <p>Dimensions: 13.5 [0.531], 8.5 [0.335] (2 PLCS), 4.7 [0.185], 5.5 [0.217] (2 PLCS), 11.0 [0.433], 0.7X2.2 (3 PLCS), $\phi 0.9$ [0.035] (3 PLCS) $+0.1$ -0.0, 0.9 [0.035], 6.8 [0.268]</p>	 <p>Dimensions: 0.90, 3-$\phi 1$, 2-$\phi 2.5$, 1.00, 2, 1, 2.50, 13.40, 4.70, 8.50, 11.00</p>
 <p>HOLE LAYOUT TOP VIEW</p> <p>Dimensions: 13.5 [0.531], 8.5 [0.335] (2 PLCS), 4.7 [0.185], 5.5 [0.217] (2 PLCS), 11.0 [0.433] (2 PLCS), 0.7X2.2 (3 PLCS), $\phi 0.9$ [0.035] (4 PLCS) $+0.1$ -0.0, 6.8 [0.268]</p>	 <p>Dimensions: 6.50, 8-$\phi 1$, 2-$\phi 2.5$, 1.00, 5, 5, 2.50, 13.40, 4.70, 8.50, 11.00</p>
 <p>HOLE LAYOUT TOP VIEW</p> <p>Dimensions: 13.5 [0.531], 8.5 [0.335] (3 PLCS), 4.7 [0.185], 5.5 [0.217] (2 PLCS), 11.0 [0.433] (2 PLCS), 0.7X2.2 (3 PLCS), $\phi 0.9$ [0.035] (5 PLCS) $+0.1$ -0.0, 1.3 [0.051], 6.8 [0.268]</p>	 <p>Dimensions: 6.50, 1.30, 8-$\phi 1$, 2-$\phi 2.5$, 1.00, 5, 4, 3, 1, 2, 2.50, 13.40, 4.70, 8.50, 11.00</p>
 <p>HOLE LAYOUT TOP VIEW</p> <p>Dimensions: 13.5 [0.531], 8.5 [0.335] (4 PLCS), 4.7 [0.185], 5.5 [0.217] (2 PLCS), 11.0 [0.433] (2 PLCS), 0.7X2.2 (3 PLCS), $\phi 0.9$ [0.035] (6 PLCS) $+0.1$ -0.0, 2.6 [0.102], 6.8 [0.268]</p>	 <p>Dimensions: 6.50, 2.60, 8-$\phi 1$, 2-$\phi 2.5$, 1.00, 8, 6, 3, 2, 1, 5, 2.50, 13.40, 4.70, 8.50, 11.00</p>

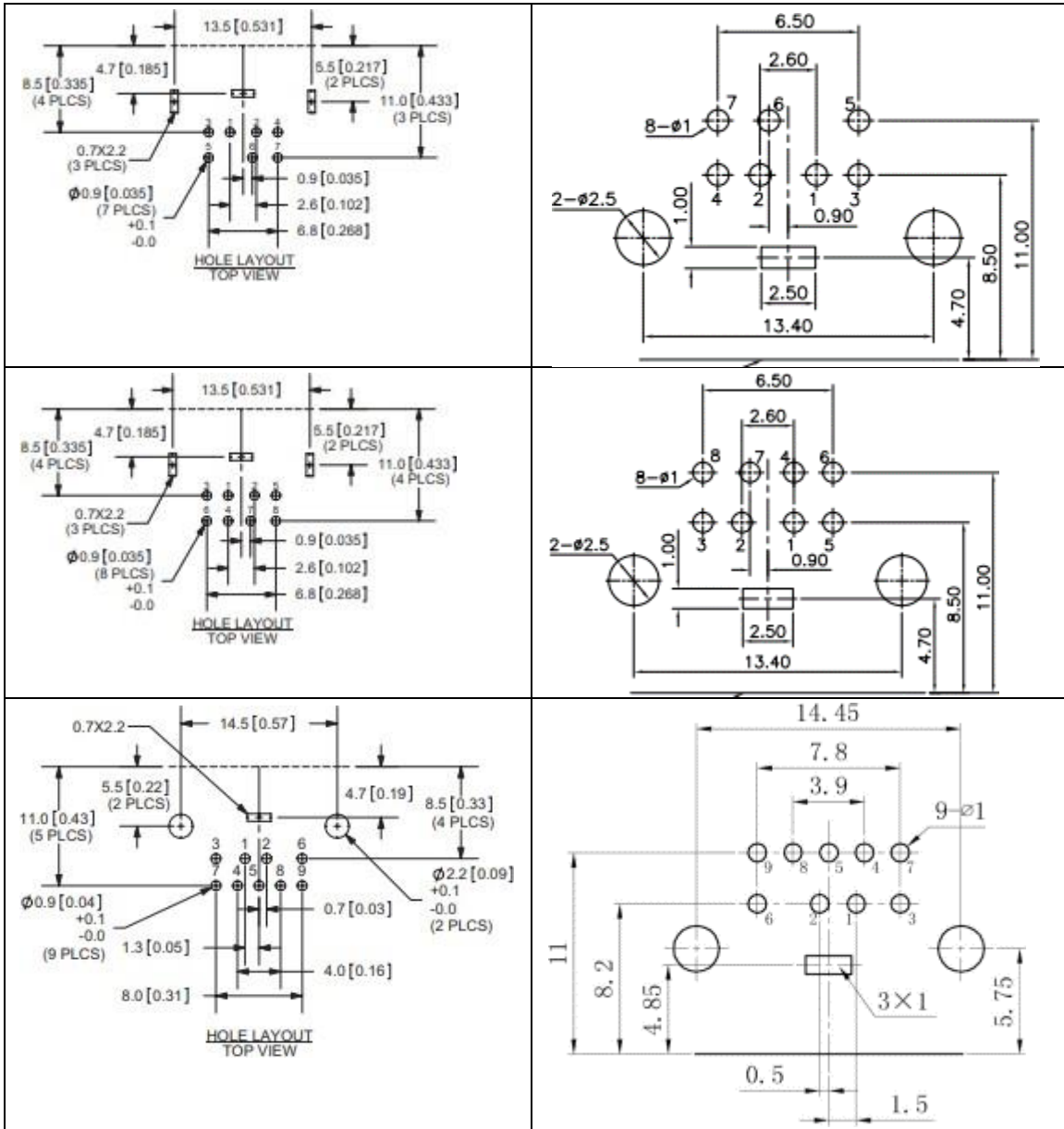

Old design materials

	MATERIAL	PLATING
earth terminal	brass	tin
contact terminals (1~9)	phosphor bronze	silver
shielding plate	steel	tin
housing	PBT	

New design materials

	MATERIAL	PLATING
body	PBT+30%GF (UL94V-0)	
pins	brass	tin
shield	brass	nickel

Affected Date Code:

11/15/2019 for MD-30SM, MD-50SM, MD-70SM, MD-80SM
12/6/19 for MD-40SM, MD-60SM, MD-90SM

Product Availability: currently available

Additional Information: none

CUI DEVICES

20050 SW 112th Ave. Tualatin, Oregon 97062
phone: 800.275.4899 fax: 503.612.2383
www.cuidevices.com

PCN Approval:

Operations/Quality



Product Marketing