

**SERIES:** CP60 | **DESCRIPTION:** PELTIER MODULE

**FEATURES**

- solid state device
- precise temperature control
- quiet operation

**MODEL**

	input voltage <sup>1</sup> max [Vdc]	input current <sup>2</sup> max [A]	internal resistance <sup>3</sup> typ [Ω±10%]	output Qmax <sup>4</sup>		output ΔTmax <sup>5</sup>	
				T <sub>n</sub> =27°C [W]	T <sub>n</sub> =50°C [W]	T <sub>h</sub> =27°C [°C]	T <sub>h</sub> =50°C [°C]
CP60133	3.8	6.0	0.51	12.2	13.6	66	72
CP60233	8.6	6.0	1.20	27.9	31.2	66	72
CP60333	15.4	6.0	2.20	50.5	56.5	66	72
CP60140	2.1	6.0	0.29	7.1	7.9	68	75
CP60240	3.8	6.0	0.53	13.0	14.5	68	75
CP60301540	4.2	6.0	0.57	14.5	16.1	68	75
CP60340	8.6	6.0	1.21	29.0	32.4	68	75
CP60440	15.4	6.0	2.17	53.0	59.3	68	75

Notes: 1. Maximum voltage at ΔT max and T<sub>n</sub>=27°C  
 2. Maximum current to achieve ΔT max  
 3. Measured by AC 4-terminal method at 25°C  
 4. Maximum heat absorbed at cold side occurs at I<sub>max</sub>, V<sub>max</sub>, and ΔT=0°C  
 5. Maximum temperature difference occurs at I<sub>max</sub>, V<sub>max</sub>, and Q=0W (ΔT max measured in a vacuum at 1.3 Pa)

## SPECIFICATIONS

parameter	conditions/description	min	typ	max	units
solder melting temperature	connection between thermoelectric pairs	235			°C
	CP60133, CP60233, CP60333, CP60301540 all other models	138			°C
assembly compression				1	MPa
hot side plate				80	°C
RoHS	yes				

## MECHANICAL DRAWING

units: mm

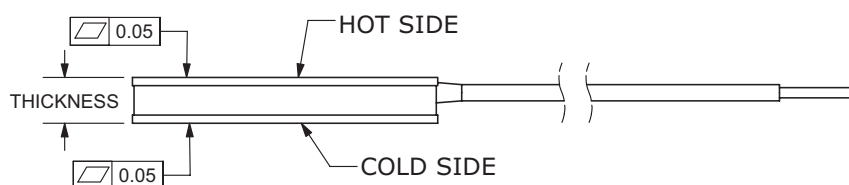

	MATERIAL	PLATING
ceramic plate	96% AL <sub>2</sub> O <sub>3</sub>	
wire leads	20 AWG	tin
sealer	silicon rubber 703 RTV (between cold and hot side plates)	
joint cover	silicon rubber 703 RTV	
marking	P/N & S/N printed on cold side surface	

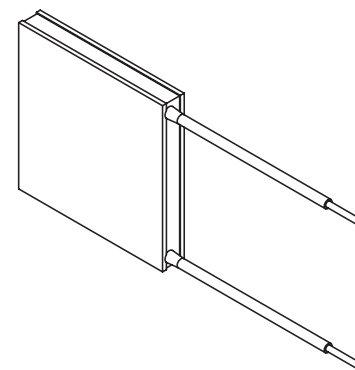
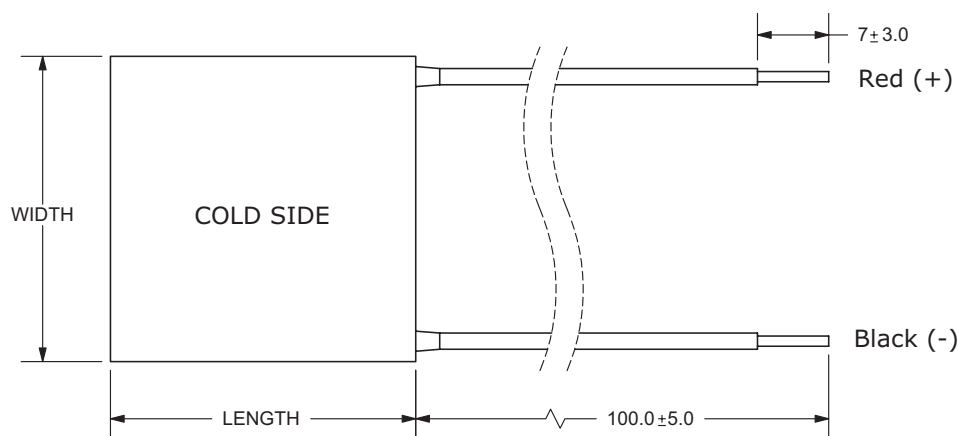

MODEL NO.	LENGTH (mm)	WIDTH (mm)	THICKNESS (mm)
CP60133	15 ±0.3	15 ±0.3	3.22 ±0.1
CP60233	20 ±0.3	20 ±0.3	3.22 ±0.1
CP60333	30 ±0.3	30 ±0.3	3.22 ±0.1
CP60140	15 ±0.3	15 ±0.3	4.0 ±0.1
CP60240	20 ±0.3	20 ±0.3	4.0 ±0.1
CP60301540	30 ±0.3	15 ±0.3	4.0 ±0.1
CP60340	30 ±0.3	30 ±0.3	4.0 ±0.1
CP60440	40 ±0.3	40 ±0.3	4.0 ±0.1

## CP60133 PERFORMANCE (Th=27°C)

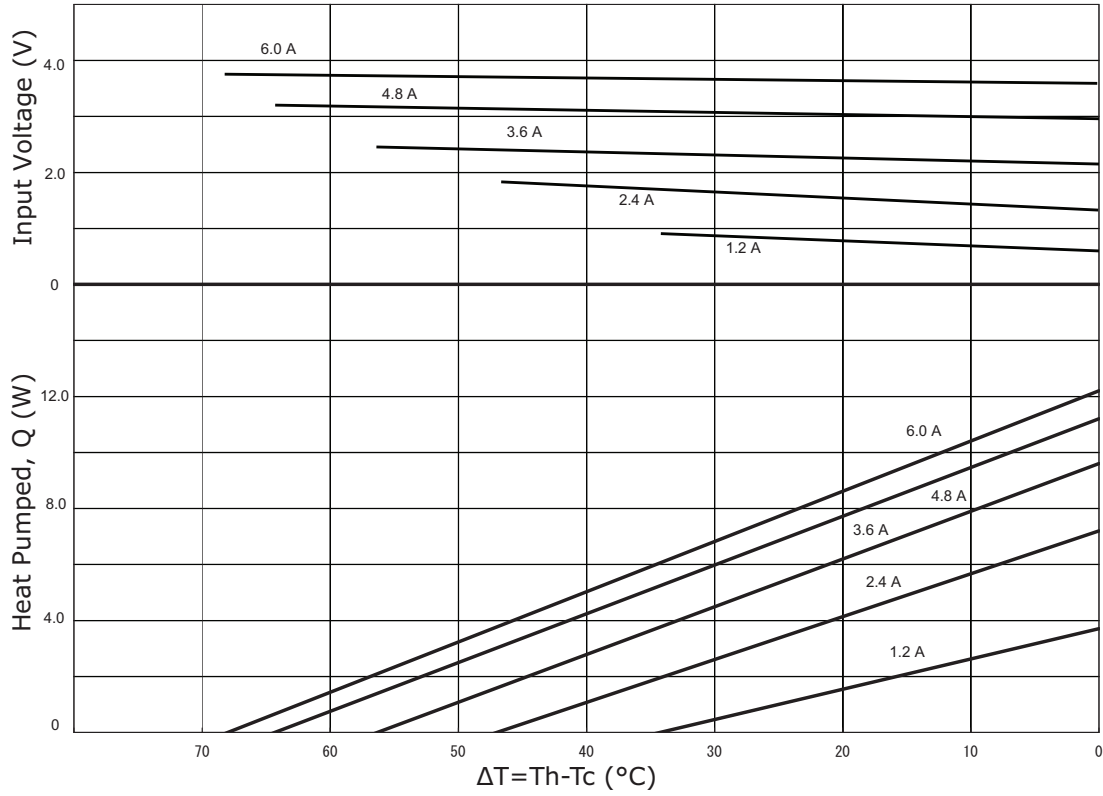

## CP60133 PERFORMANCE (Th=50°C)

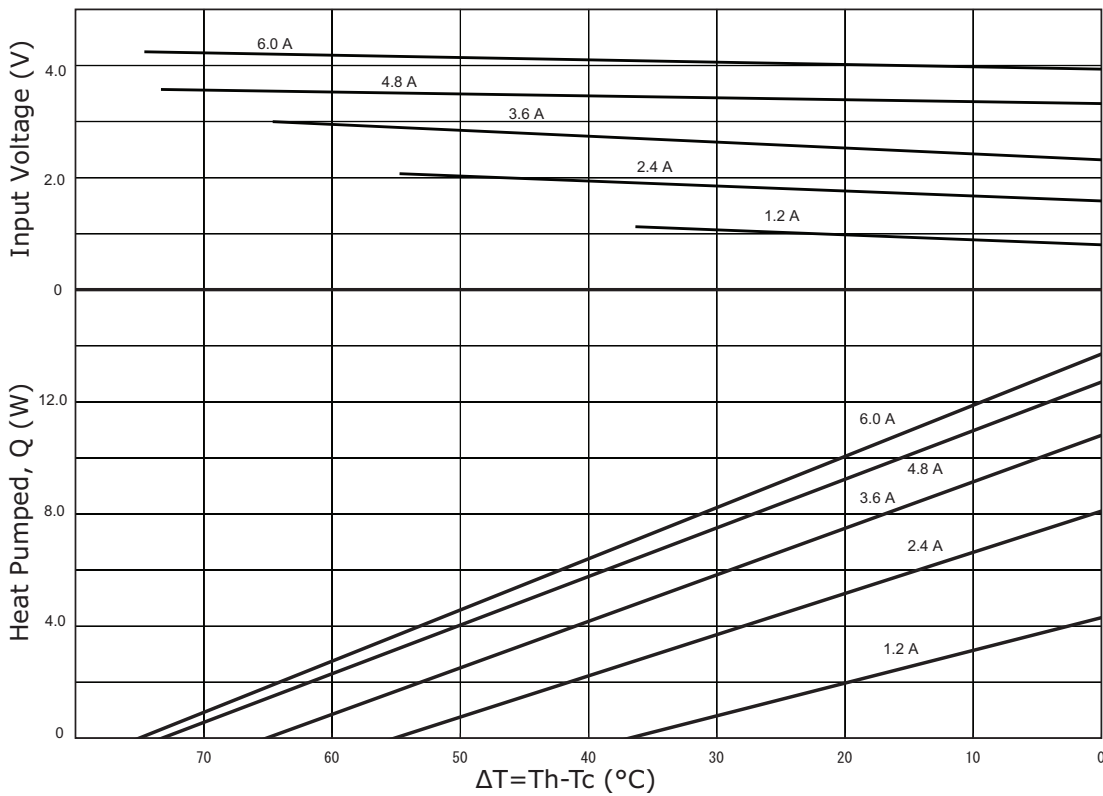

## CP60233 PERFORMANCE (Th=27°C)

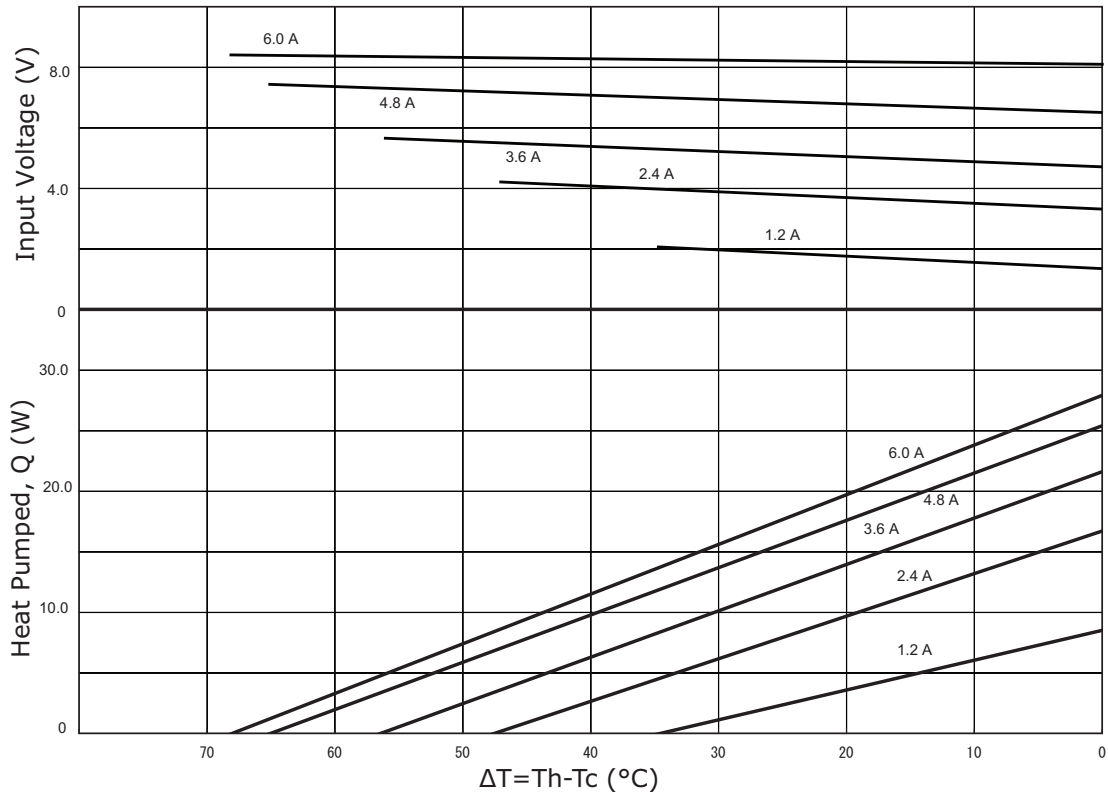

## CP60233 PERFORMANCE (Th=50°C)

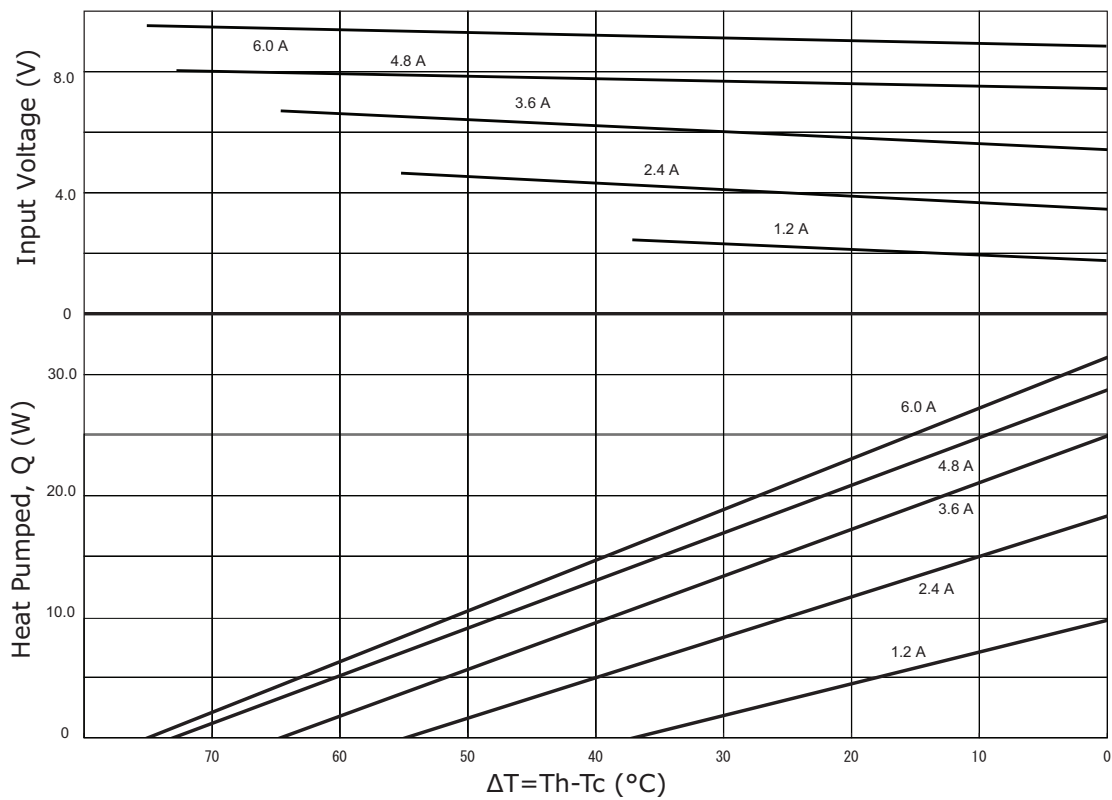

### CP60333 PERFORMANCE (Th=27°C)

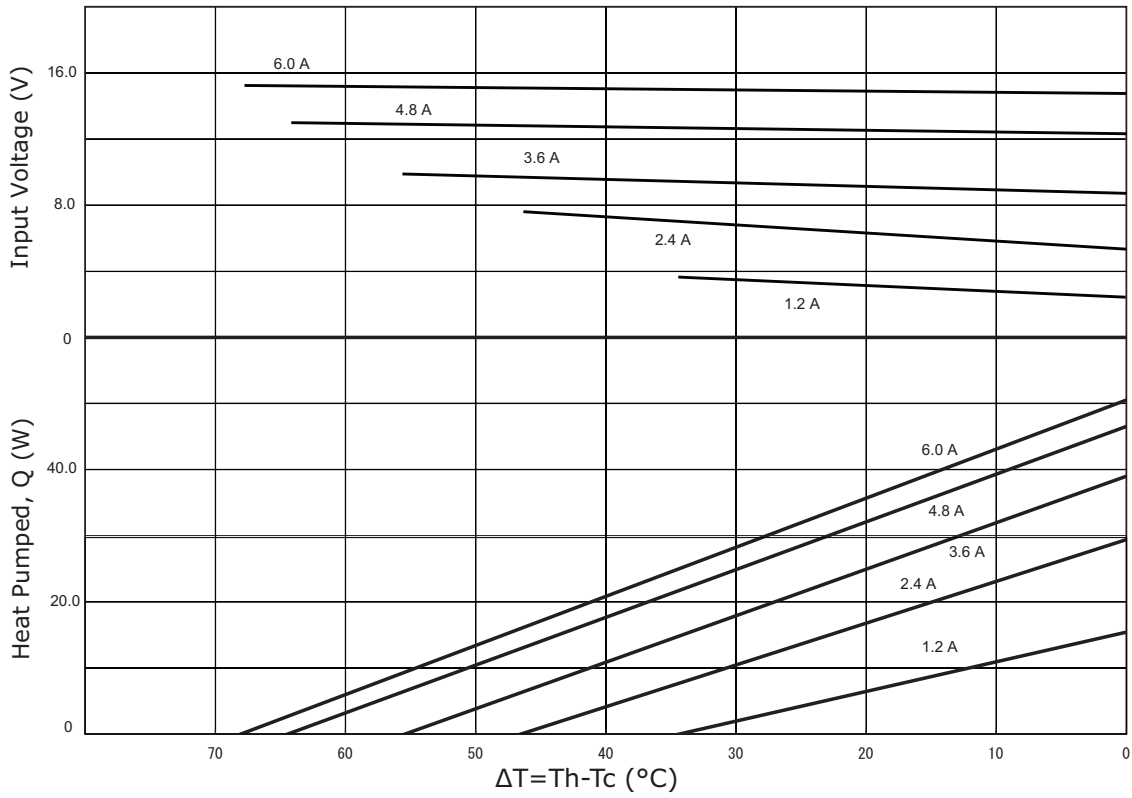

### CP60333 PERFORMANCE (Th=50°C)

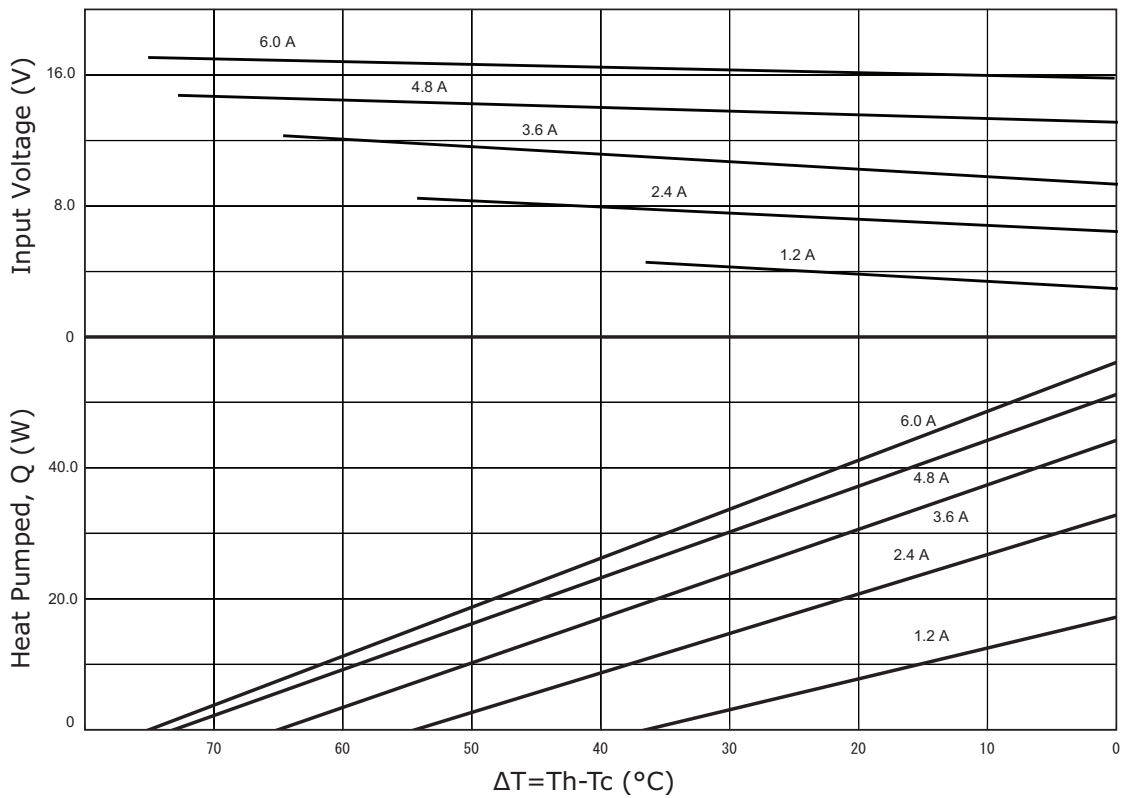

## CP60140 PERFORMANCE (Th=27°C)

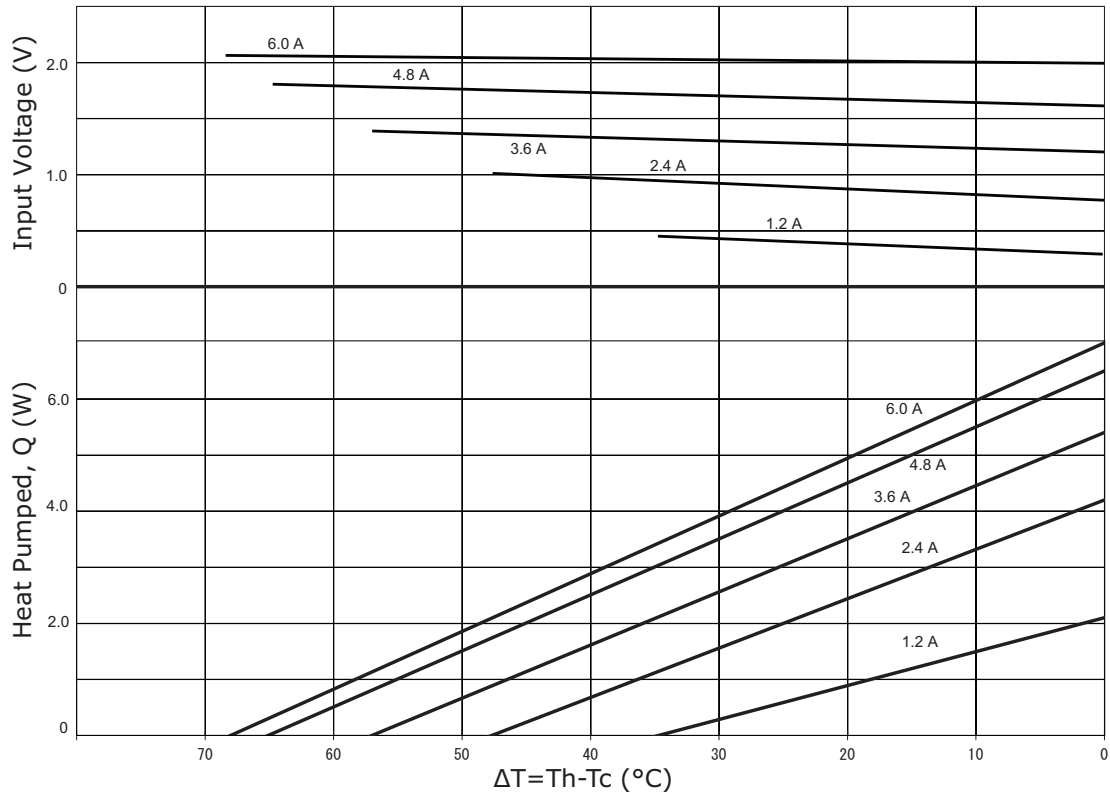

## CP60140 PERFORMANCE (Th=50°C)

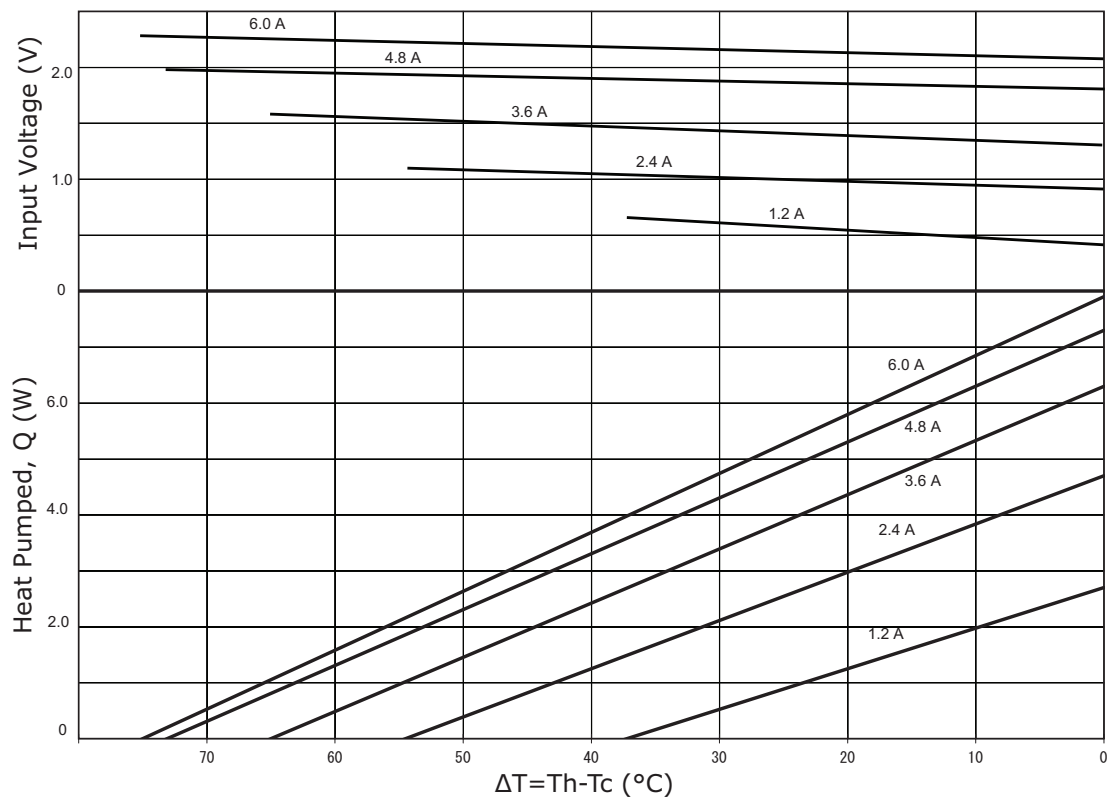

## CP60240 PERFORMANCE (Th=27°C)

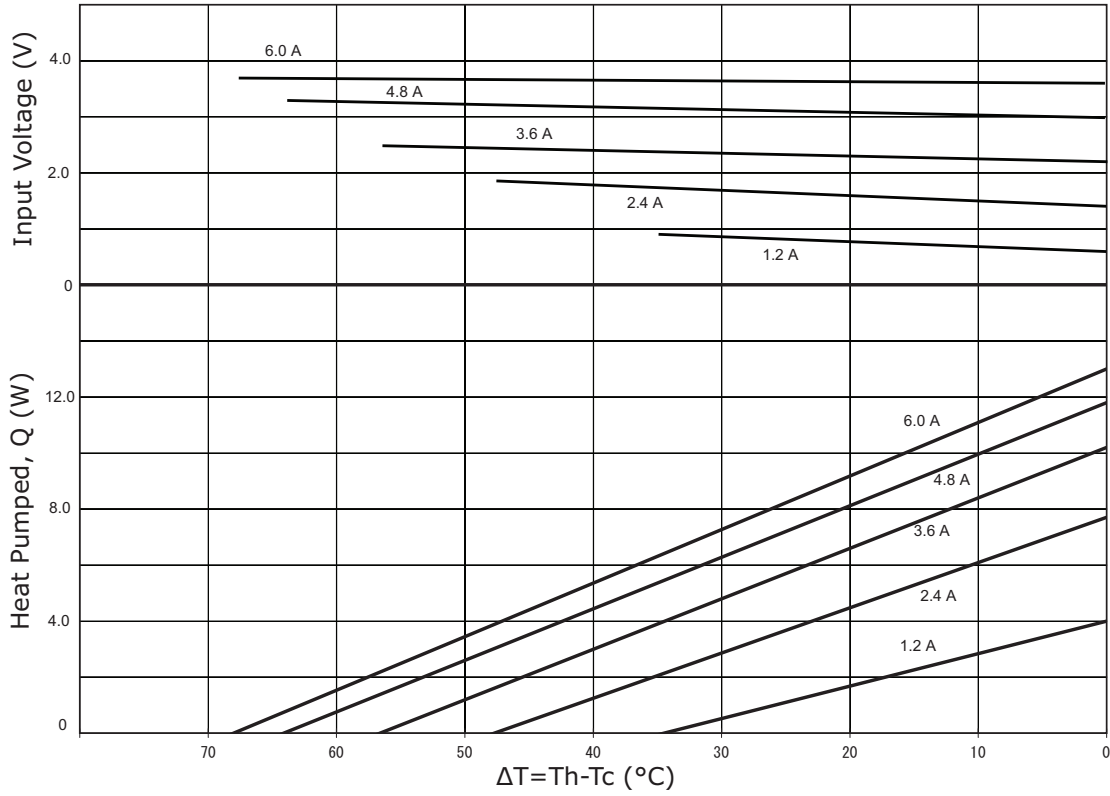

## CP60240 PERFORMANCE (Th=50°C)

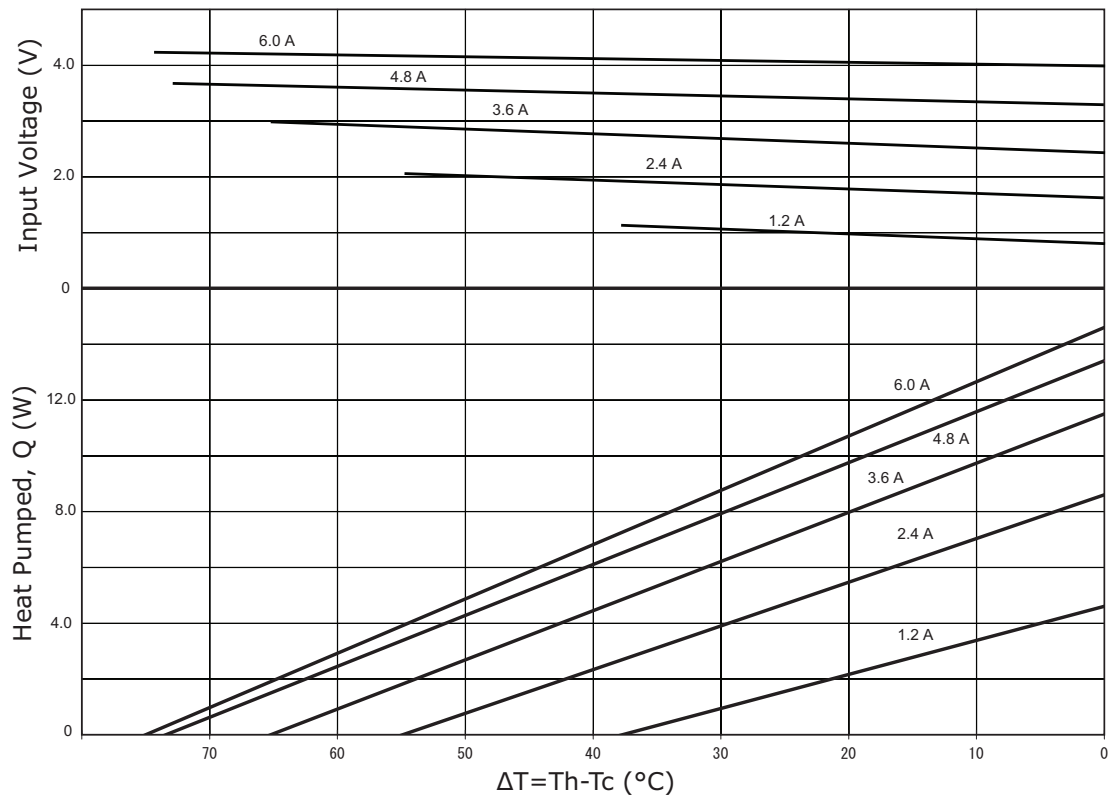

## CP60301540 PERFORMANCE (Th=27°C)

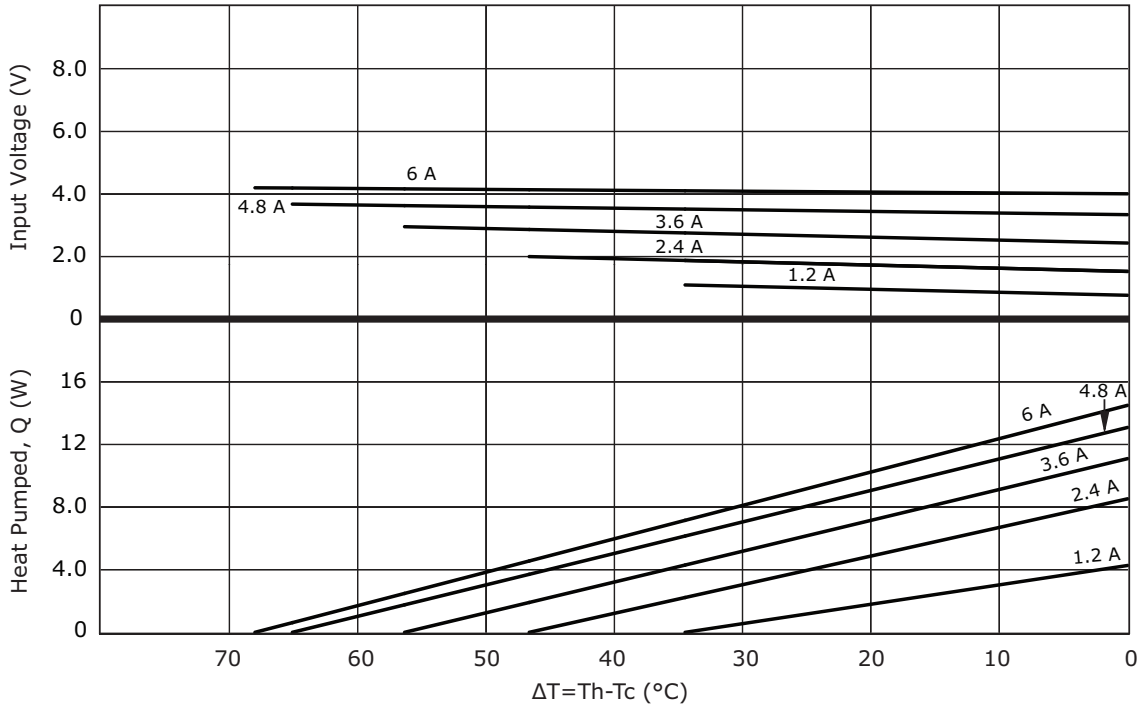

## CP60301540 PERFORMANCE (Th=50°C)

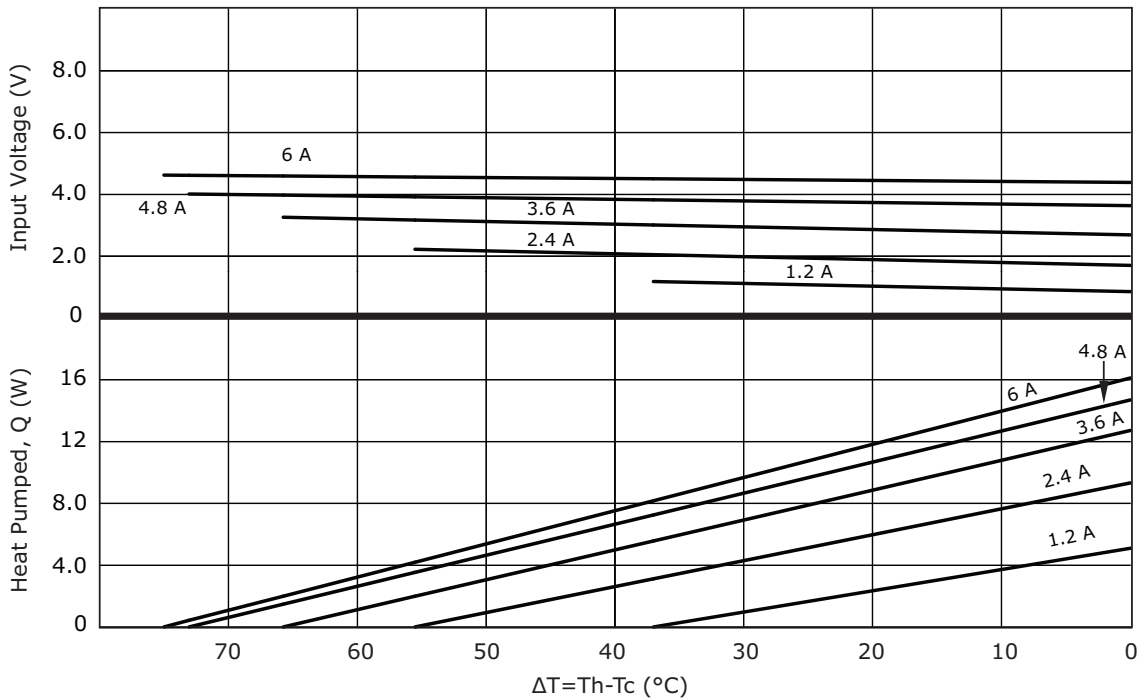



## CP60340 PERFORMANCE (Th=27°C)

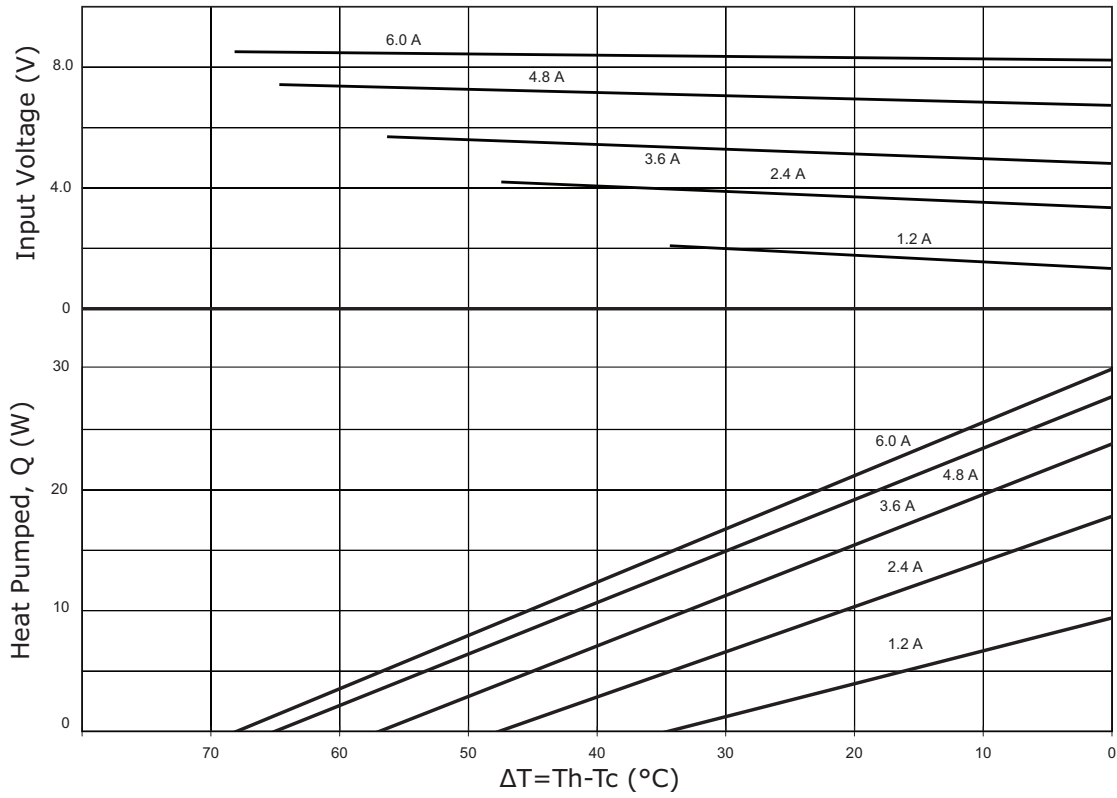

## CP60340 PERFORMANCE (Th=50°C)

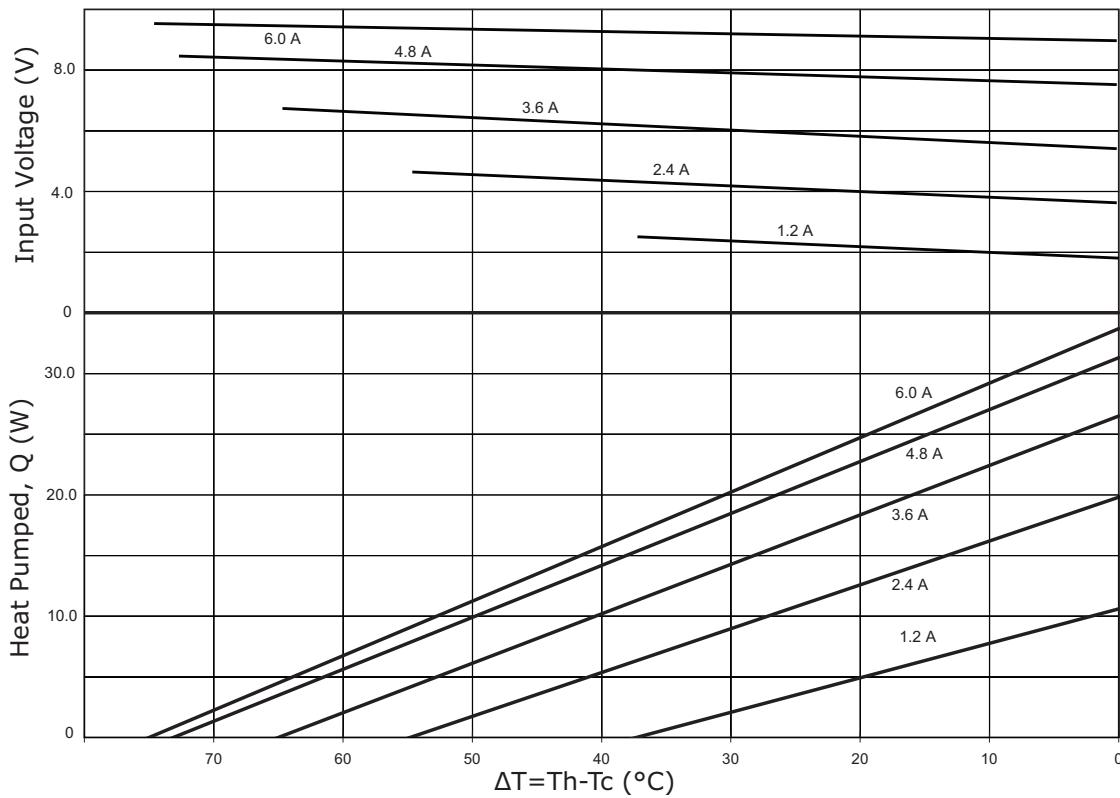

## CP60440 PERFORMANCE (Th=27°C)

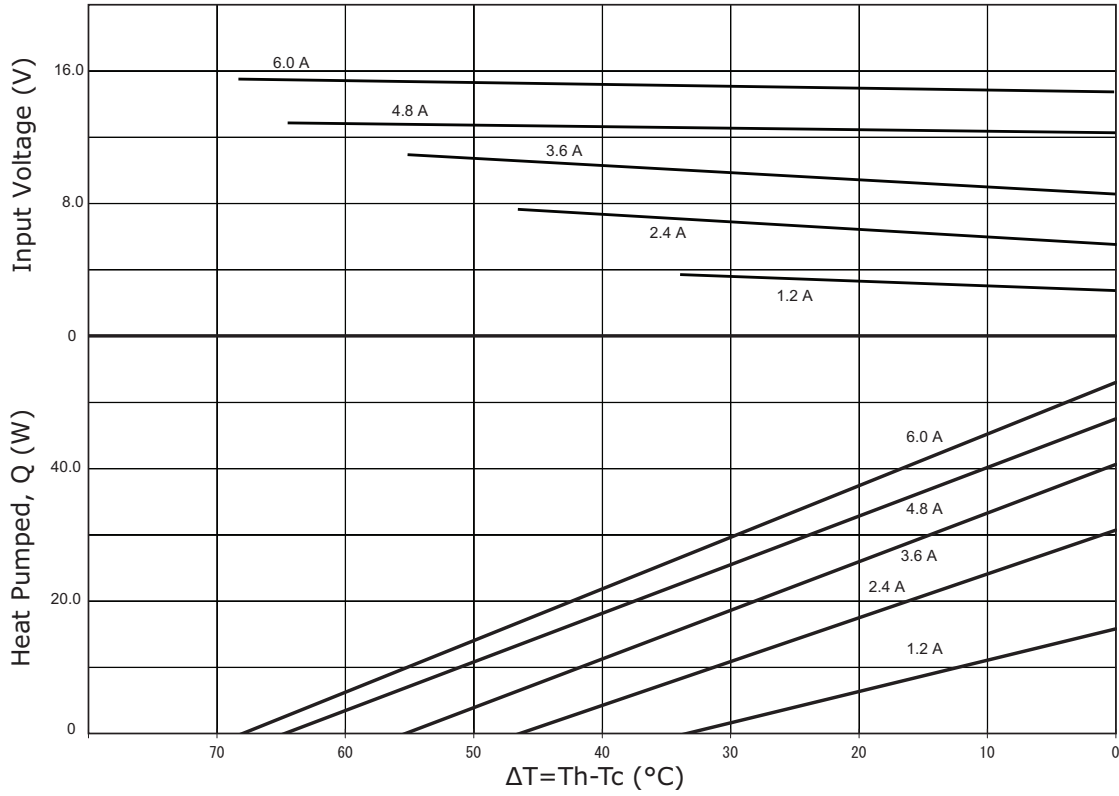

## CP60440 PERFORMANCE (Th=50°C)

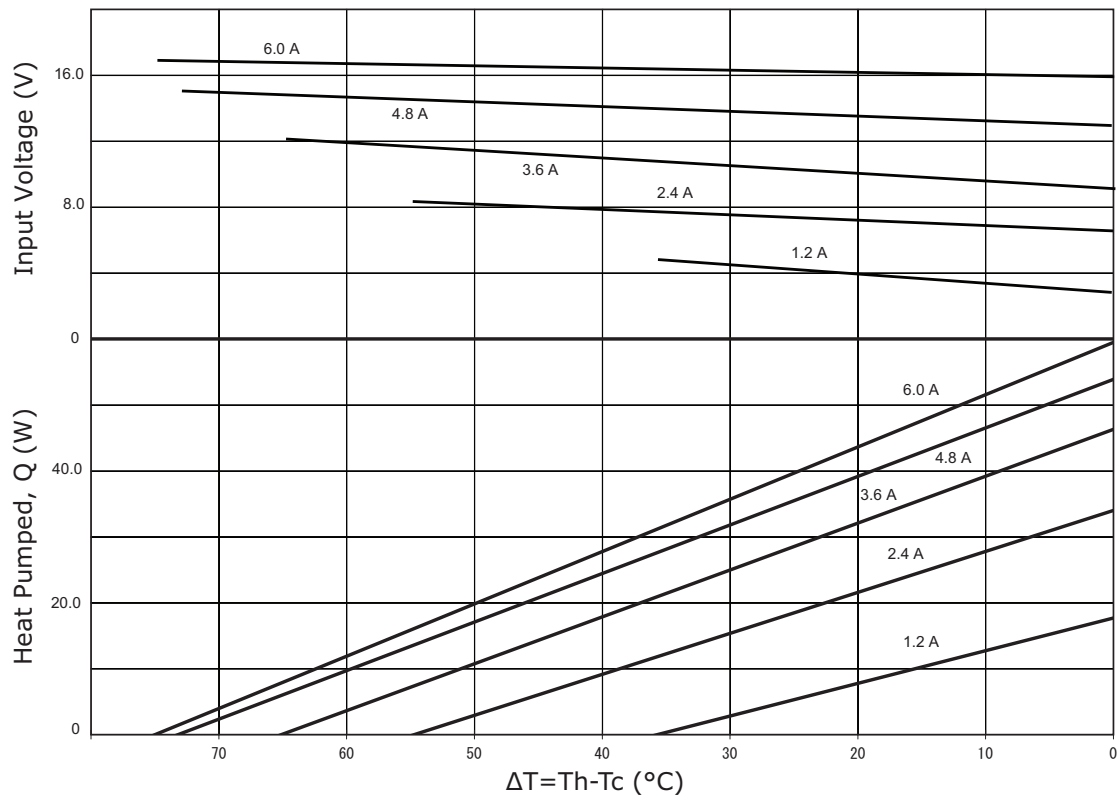

## REVISION HISTORY

rev.	description	date
1.0	initial release	09/03/2009
1.01	applied new template	05/08/2012
1.02	added new models	09/09/2016
1.03	changed thickness of CP60133, CP60233, CP60333, CP60301540 models	09/20/2018
1.04	brand update	10/28/2019
1.05	logo, datasheet style update	08/05/2022

The revision history provided is for informational purposes only and is believed to be accurate.



CUI Devices offers a one (1) year limited warranty. Complete warranty information is listed on our website.

CUI Devices reserves the right to make changes to the product at any time without notice. Information provided by CUI Devices is believed to be accurate and reliable. However, no responsibility is assumed by CUI Devices for its use, nor for any infringements of patents or other rights of third parties which may result from its use.

CUI Devices products are not authorized or warranted for use as critical components in equipment that requires an extremely high level of reliability. A critical component is any component of a life support device or system whose failure to perform can be reasonably expected to cause the failure of the life support device or system, or to affect its safety or effectiveness.

[cuidevices.com](http://cuidevices.com)