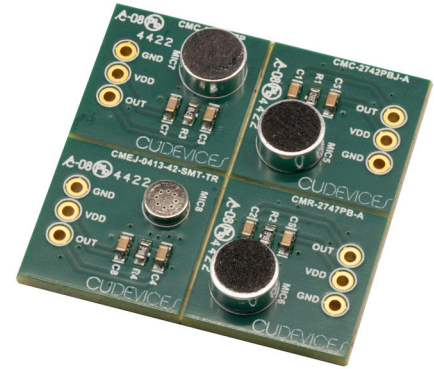

MODEL: DEVKIT-ECM-001 | **DESCRIPTION:** MICROPHONE DEVELOPMENT KIT**FEATURES**

- 4 detachable evaluation boards
- 1 noise cancelling, 1 unidirectional, & 2 omnidirectional ECM's included
- plated through hole I/O terminals for multiple testing options

**EVAL BOARD**

	circuit	technology	output	acoustic port	size dia (mm)	sensitivity typ (dB)	current typ (µA)
CMC-2742PBJ-A	MIC5	ECM	analog	top	6.0	-42	400
CMR-2747PB-A	MIC6	ECM	analog	top	6.0	-47	500
CMC-6015-47P	MIC7	ECM	analog	top	6.0	-47	500
CMEJ-0413-42-SMT-TR	MIC8	ECM	analog	top	4.0	-42	500

OPERATIONAL INSTRUCTIONS

The CUI Devices electret condenser microphone (ECM) evaluation board consists of four independent microphone evaluation circuits. One of the microphones is constructed to be noise cancelling, one is constructed to provide unidirectional sound capture, and 2 are constructed to provide omnidirectional sound capture. External bypass capacitors are included on the power supply rails of the evaluation boards and DC blocking capacitors are placed in the analog output signal paths.

A DC power supply of 2-10 Volts should be connected between the VDD and GND pins for the ECM evaluation circuits. The recommended operating voltage for all of the evaluation boards is 2 V.

Please refer to the respective data sheets for additional information regarding each of the microphones.

CIRCUIT DIAGRAMS & BOARD LAYOUTS

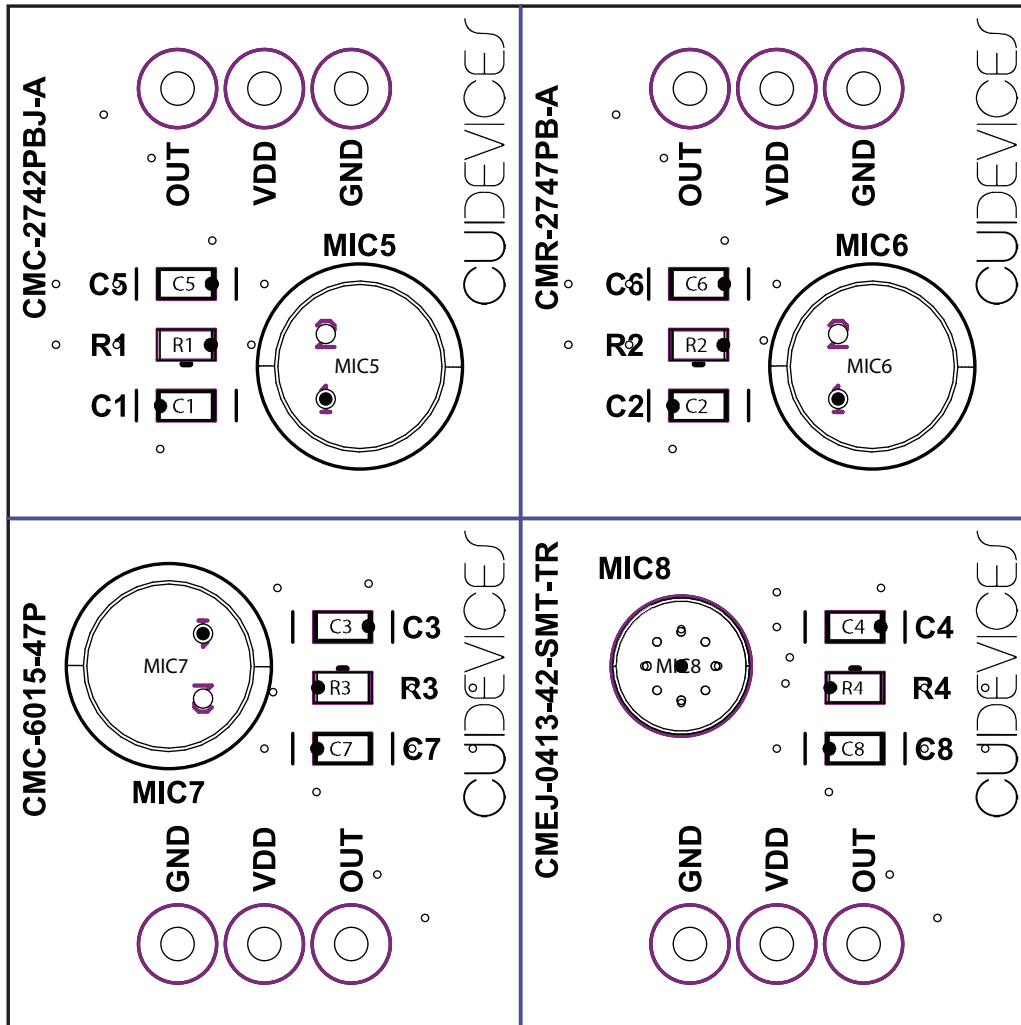
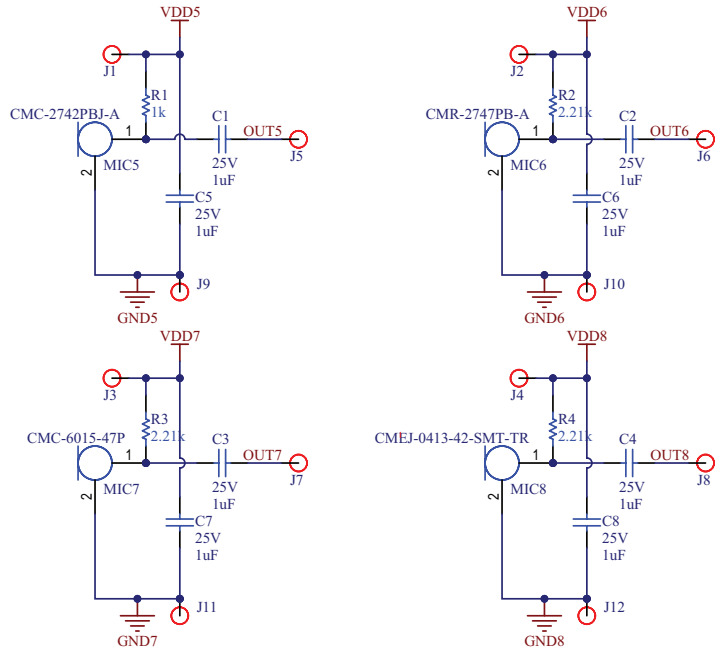
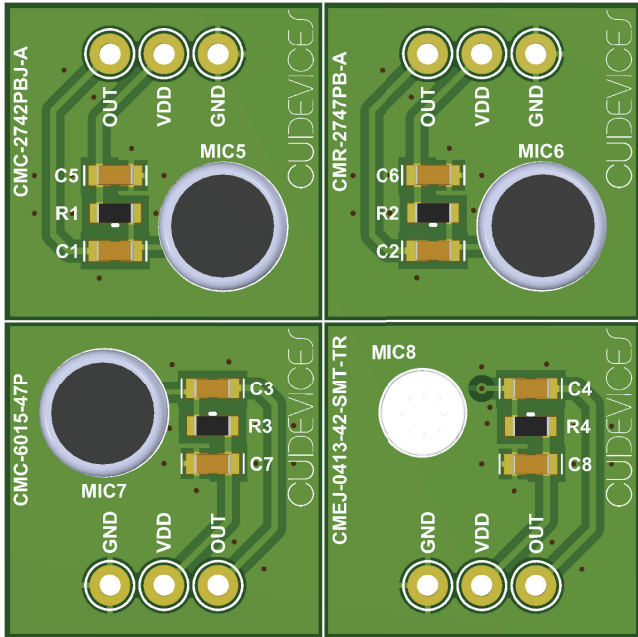

CMC -2742PBJ-A

WWW.CUIDEVICES.COM/PRODUCT/AUDIO/MICROPHONES/MEMS-MICROPHONES/CMC-2742PBJ-A

ELECTRICAL

parameter	conditions/description	min	typ	max	units
directivity	omnidirectional				
sensitivity (S)	f = 1 kHz, 1 Pa, 0 dB = 1 V/Pa	-45	-42	-39	dB
supply voltage (V _{DD})			2	10	Vdc
current consumption (I _{loss})	V _s = 2.0 Vdc, R _L = 2.2 k Ω			400	μ A
sensitivity reduction	f = 1 kHz, 1 Pa, V _s = 2.0 ~ 1.5 Vdc		-3		dB
frequency (f)		100		20,000	Hz
signal to noise ratio (S/N)	f = 1 kHz, 1 Pa, A-weighted		58		dBA
output impedance (Z _{out})	f = 1 kHz, 1 Pa		2.2		k Ω

Notes: 1. All specifications measured at 23 \pm 2°C, humidity at 55 \pm 20%, unless otherwise noted.

FREQUENCY RESPONSE CURVE

X:1.0000kHz *Y:-42.00dB ZA:Live Curve SSR Fund.

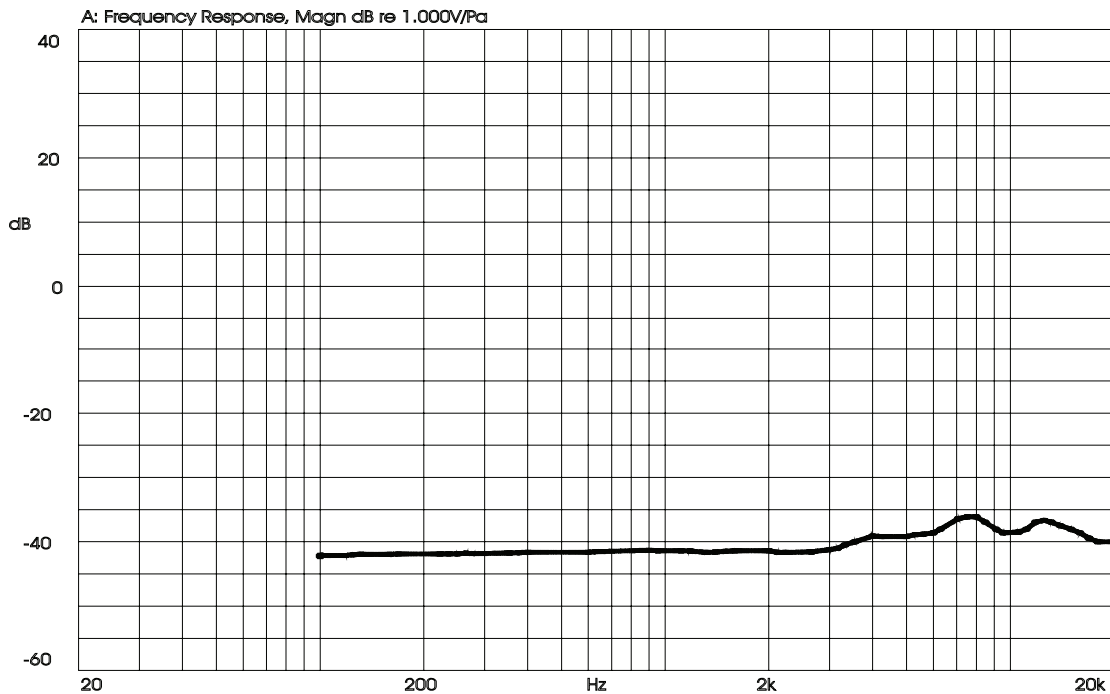

CMR-2747PB-A

WWW.CUIDEVICES.COM/PRODUCT/AUDIO/MICROPHONES/ELECTRET-CONDENSER-MICROPHONES/CMR-2747PB-A

ELECTRICAL

parameter	conditions/description	min	typ	max	units
directivity	noise cancelling				
sensitivity (S)	at 94 dB SPL, 1 kHz	-50	-47	-44	dB
supply voltage (V _{DD})		2.0		10.0	V
current consumption (I _{DD})	V _{DD} = 2.0 V			500	μA
sensitivity reduction	V _{DD} = 2.0 ~ 1.5 V		-3		dB
frequency (f)		100		20,000	Hz
signal to noise ratio (S/N)	at 94 dB SPL, 1 kHz (A-weighted)		56		dBA
total harmonic distortion (THD)	at 94 dB SPL, 1 kHz			10	%
acoustic overload point (AOP)	at 10% THD, 1 kHz		110		dB SPL
output impedance (Z _{out})	at 1 kHz		2,200		Ω

Notes: 1. All specifications measured at 23±2°C, humidity at 55±20%, unless otherwise noted.

FREQUENCY RESPONSE CURVE

X:1.0000kHz *Y:-47.00dB Z:Live Curve SSR Fund.

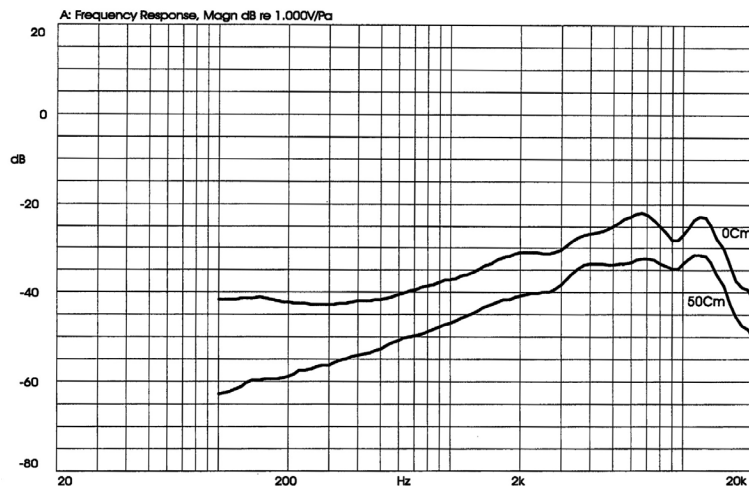

CMC-6015-47P

WWW.CUIDEVICES.COM/PRODUCT/AUDIO/MICROPHONES/ELECTRET-CONDENSER-MICROPHONES/CMC-6015-47P

ELECTRICAL

parameter	conditions/description	min	typ	max	units
directivity	unidirectional				
sensitivity (S)	at 94 dB SPL, 1 kHz	-50	-47	-44	dB
supply voltage (V _{DD})		2.0		10.0	V
current consumption (I _{DD})	V _{DD} = 2.0 V			500	μA
sensitivity reduction	V _{DD} = 2.0 ~ 1.5 V		-3		dB
frequency (f)		100		20,000	Hz
signal to noise ratio (S/N)	at 94 dB SPL, 1 kHz [A-weighted]		56		dBA
total harmonic distortion (THD)	at 94 dB SPL, 1 kHz			10	%
acoustic overload point (AOP)	at 10% THD, 1 kHz		110		dB SPL
output impedance (Z _{out})	at 1 kHz		2,200		Ω

Notes: 1. All specifications measured at 23±2°C, humidity at 55±20%, unless otherwise noted.

FREQUENCY RESPONSE CURVE

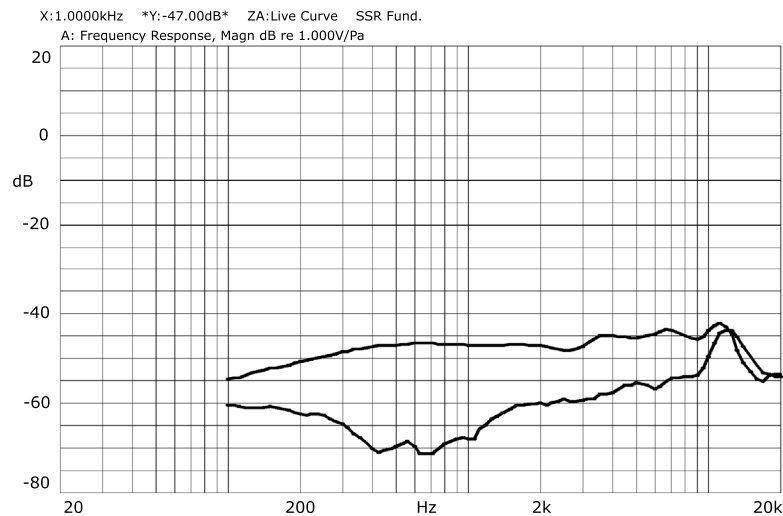

CMEJ-0413-42-SMT-TR

WWW.CUIDEVICES.COM/PRODUCT/AUDIO/MICROPHONES/ELECTRET-CONDENSER-MICROPHONES/CMEJ-0413-42-SMT-TR

ELECTRICAL

parameter	conditions/description	min	typ	max	units
directivity	omnidirectional				
sensitivity (S)	at 1 kHz [0 dB = 1 V/Pa]	-45	-42	-39	dB
supply voltage (V _{DD})		1.0	2.0	10	V
current consumption (I _{DD})	V _{DD} = 2.0 V, R _L = 2.2 k Ω			0.5	mA
sensitivity reduction	V _{DD} = 2.0 ~ 1.5 V			3	dB
frequency (f)		100		10,000	Hz
signal to noise ratio (S/N)	at 1 kHz, P _{in} = 1 Pa [A-weighted]		60		dBA
total harmonic distortion (THD)	at 94 dB SPL, 1 kHz at 115 dB SPL, 1 kHz			1 3	% %
acoustic overload point (AOP)	at 1 kHz			115	dB SPL
output impedance (Z _{out})	at 1 kHz			2.2	k Ω

Notes: 1. All specifications measured at 23 \pm 2°C, humidity at 55 \pm 20%, unless otherwise noted.

FREQUENCY RESPONSE CURVE

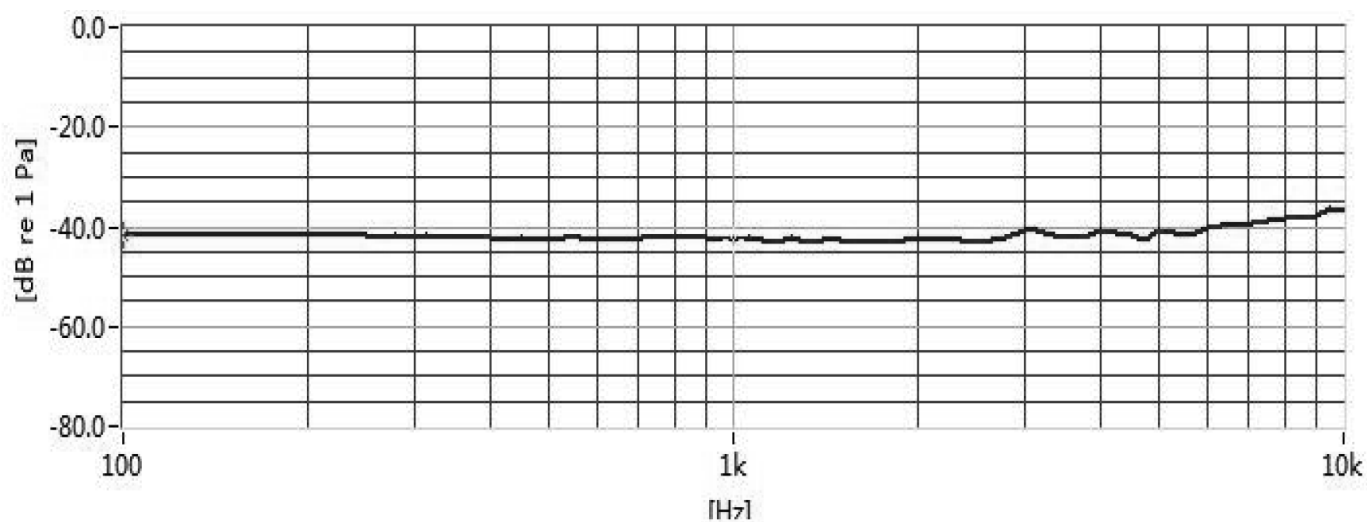

REVISION HISTORY

rev.	description	date
1.0	initial release	05/14/2019
1.01	brand update	04/02/2020
1.02	logo, datasheet style update	08/05/2022
1.03	changed microphones and modified board design	04/13/2023

The revision history provided is for informational purposes only and is believed to be accurate.



CUI Devices offers a one (1) year limited warranty. Complete warranty information is listed on our website.

CUI Devices reserves the right to make changes to the product at any time without notice. Information provided by CUI Devices is believed to be accurate and reliable. However, no responsibility is assumed by CUI Devices for its use, nor for any infringements of patents or other rights of third parties which may result from its use.

CUI Devices products are not authorized or warranted for use as critical components in equipment that requires an extremely high level of reliability. A critical component is any component of a life support device or system whose failure to perform can be reasonably expected to cause the failure of the life support device or system, or to affect its safety or effectiveness.

cuidevices.com