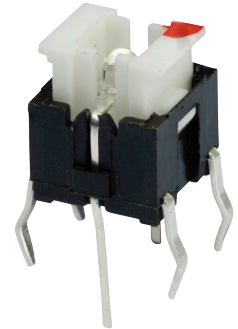

SERIES: TS27 | **DESCRIPTION:** TACTILE SWITCH

FEATURES

- illuminated
- 7 color options
- through hole

SPECIFICATIONS

parameter	conditions/description	min	typ	max	units
rated voltage		1		12	Vdc
rated current		0.01		50	mA
withstanding voltage	for 1 minute		250		Vac
contact resistance	applying load of 2 times operating force at 5 Vdc, 10 mA			100	mΩ
insulation resistance	for 1 minute at 100 Vdc	100			MΩ
operating force		210	260	310	gf
return force		20			gf
actuator travel		0.15	0.25	0.35	mm
operating temperature		-30		80	°C
storage temperature		-40		90	°C
life	at 12 Vdc, 50 mA, 1~2 cycles/second, 1.5 times operating force		100,000		cycles
vibration	10~55~10 Hz, 1.5 mm amplitude, 2 hours on each XYZ				
flammability rating	see material table				
RoHS	yes				

SOLDERABILITY

parameter	conditions/description	min	typ	max	units
hand soldering	for maximum 3 seconds			350	°C
wave soldering	for maximum 5 seconds			260	°C

PART NUMBER KEY
TS27 - 68 - 24 - XX - 260 - D

Base Number

 LED Color:
 WT = white
 BL = blue
 R = red
 G = green
 Y = yellow
 RB = red & blue
 RG = red and green

LED ABSOLUTE MAXIMUM RATINGS (WHITE) (TA=25°C)

parameter	conditions/description	min	typ	max	units
power dissipation [Pd]				120	mW
DC forward current [IF]				30	mA
peak forward current [IFP]	pulse of 1/10 duty and 0.1 ms width			100	mA
reverse voltage [VR]				5	V

LED ELECTRO-OPTICAL CHARACTERISTICS (WHITE) (TA=25°C)

parameter	conditions/description	min	typ	max	units
forward voltage [Vf]	at IF=20 mA		3.2	3.6	V
luminous intensity [Iv]	at IF=20 mA	200	400		mcd
chromacity coordinates	at IF=20 mA white	X Y	0.28 0.29		
reverse current [IR]	at VR=5 V			1	µA
viewing angle [2θ1/2]	at IF=20 mA		35		deg

LED ELECTRO-OPTICAL CHARACTERISTIC CURVES (WHITE)

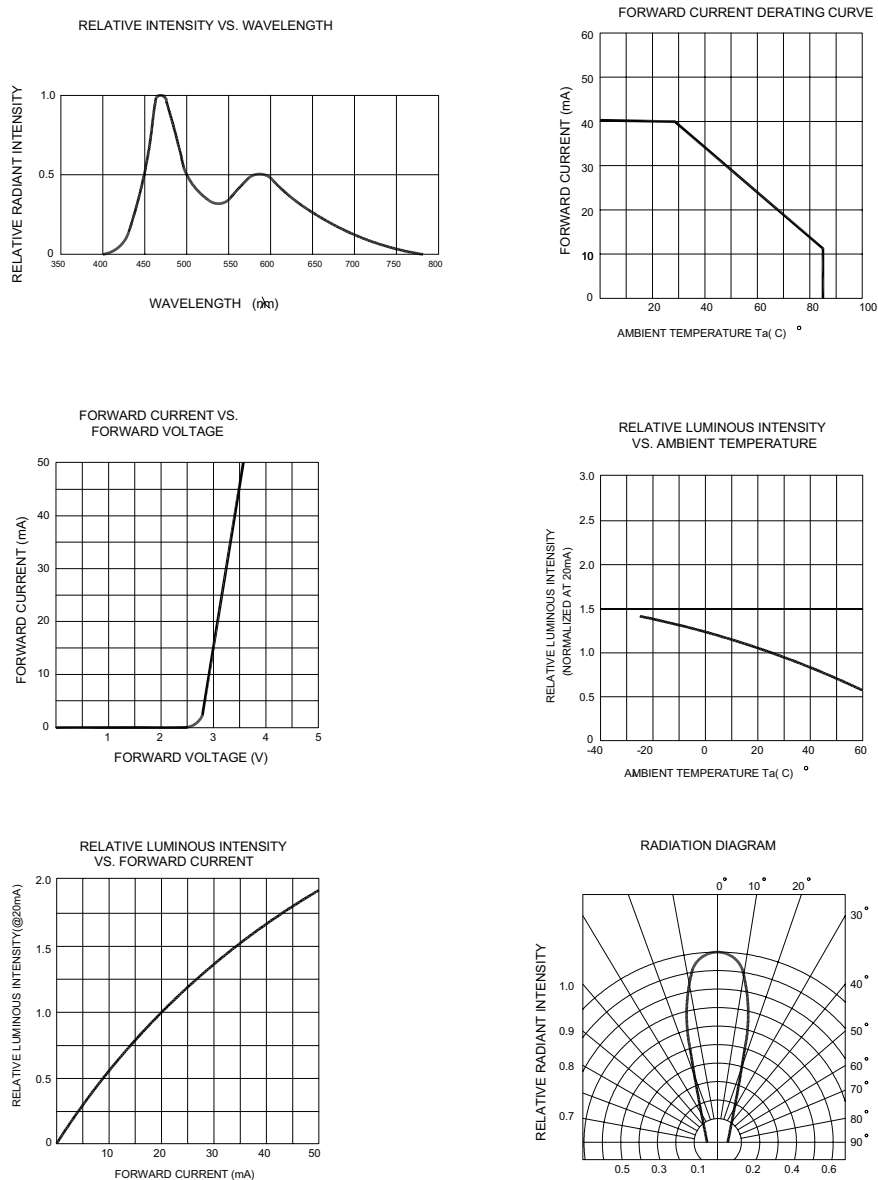

LED ABSOLUTE MAXIMUM RATINGS (BLUE) (TA=25°C)

parameter	conditions/description	min	typ	max	units
power dissipation (Pd)				120	mW
DC forward current (If)				30	mA
peak forward current (Ifp)	pulse of 1/10 duty and 0.1 ms width			100	mA
reverse voltage (Vr)				5	V

LED ELECTRO-OPTICAL CHARACTERISTICS (BLUE) (TA=25°C)

parameter	conditions/description	min	typ	max	units
forward voltage (Vf)	at If=20 mA		3.0	3.2	V
luminous intensity (Iv)	at If=20 mA	1,000	1,400		mcd
peak wavelength (λp)	at If=20 mA		460		nm
dominant wave length (λd)	at If=20 mA	465		470	nm
spectral line half-width (Δλ)	at If=20 mA		30		nm
viewing angle (2θ1/2)	at If=20 mA		30		deg

LED ELECTRO-OPTICAL CHARACTERISTIC CURVES (BLUE)

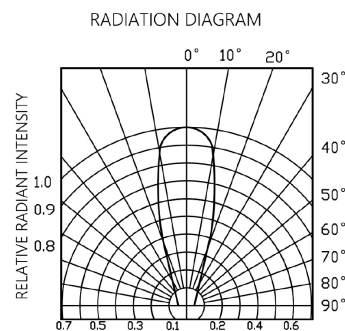
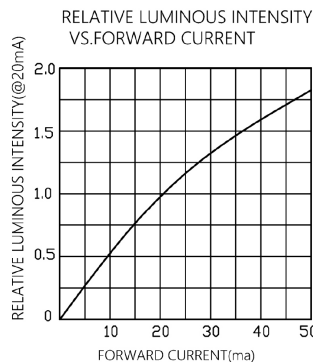
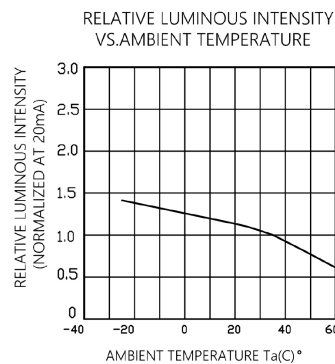
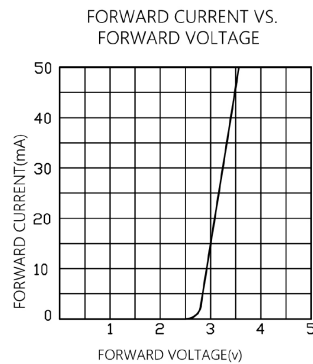
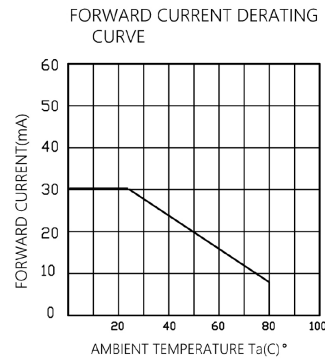
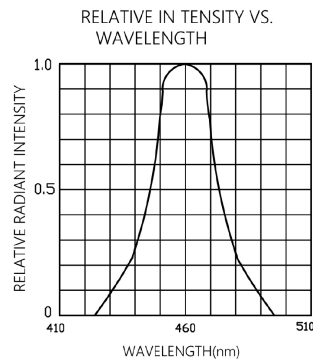

LED ABSOLUTE MAXIMUM RATINGS (RED) (TA=25°C)

parameter	conditions/description	min	typ	max	units
power dissipation [Pd]				52	mW
DC forward current [IF]				20	mA
peak forward current [IFP]	pulse of 1/10 duty and 0.1 ms width			100	mA
reverse voltage [VR]				5	V

LED ELECTRO-OPTICAL CHARACTERISTICS (RED) (TA=25°C)

parameter	conditions/description	min	typ	max	units
forward voltage [Vf]	at IF=20 mA		2.0	2.6	V
luminous intensity [Iv]	at IF=20 mA	2,600	3,000		mcd
reverse current [IR]	at VR=5 V			100	μA
peak wavelength [λp]	at IF=20 mA		622		nm
dominant wave length [λd]	at IF=20 mA	620		625	nm
spectral line half-width [Δλ]	at IF=20 mA		20		nm
viewing angle [2θ1/2]	at IF=20 mA		30		deg

LED ELECTRO-OPTICAL CHARACTERISTIC CURVES (RED)

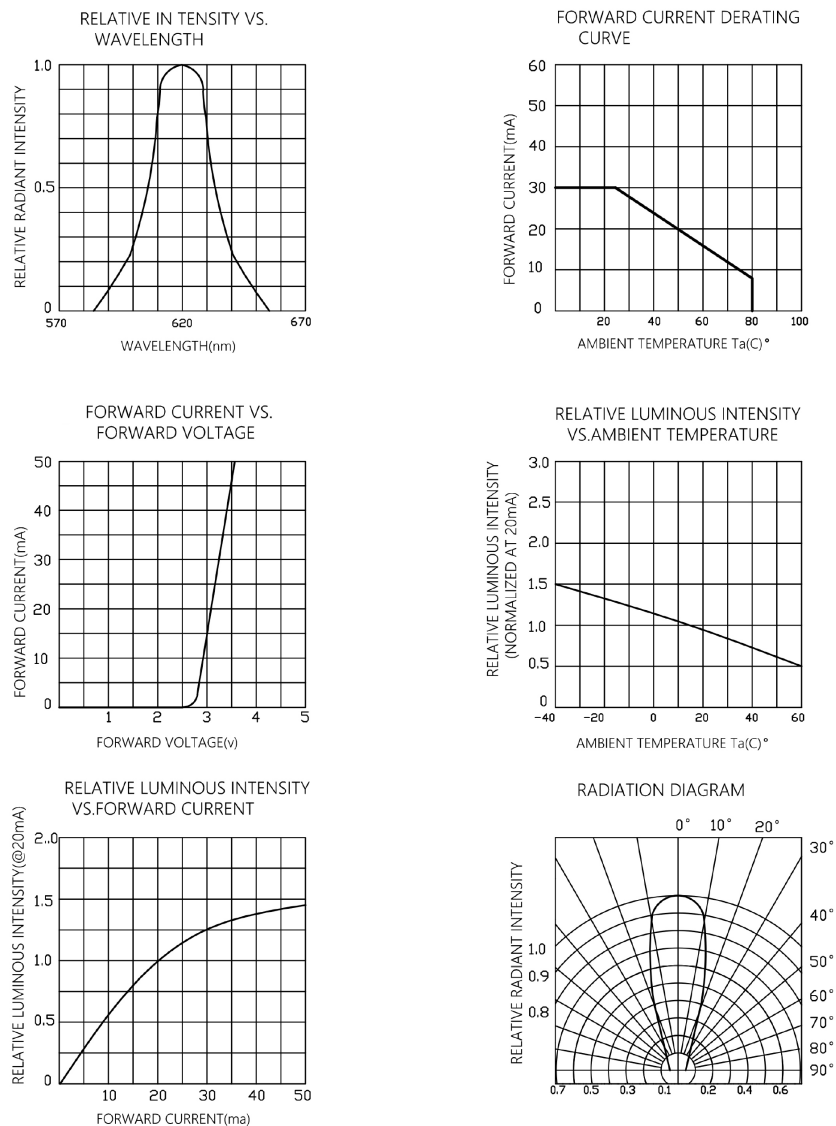

LED ABSOLUTE MAXIMUM RATINGS (GREEN) (TA=25°C)

parameter	conditions/description	min	typ	max	units
power dissipation [Pd]				72	mW
DC forward current [If]				20	mA
peak forward current [Ifp]	pulse of 1/10 duty and 0.1 ms width			100	mA
reverse voltage [VR]				5	V

LED ELECTRO-OPTICAL CHARACTERISTICS (GREEN) (TA=25°C)

parameter	conditions/description	min	typ	max	units
forward voltage [Vf]	at If=20 mA		3.2	3.6	V
luminous intensity [Iv]	at If=20 mA	14,500	15,000		mcd
reverse current [Ir]	at VR=5 V			1	μA
peak wavelength [λp]	at If=20 mA		515		nm
dominant wave length [λd]	at If=20 mA	510		525	nm
spectral line half-width [Δλ]	at If=20 mA		30		nm
viewing angle [2θ1/2]	at If=20 mA		30		deg

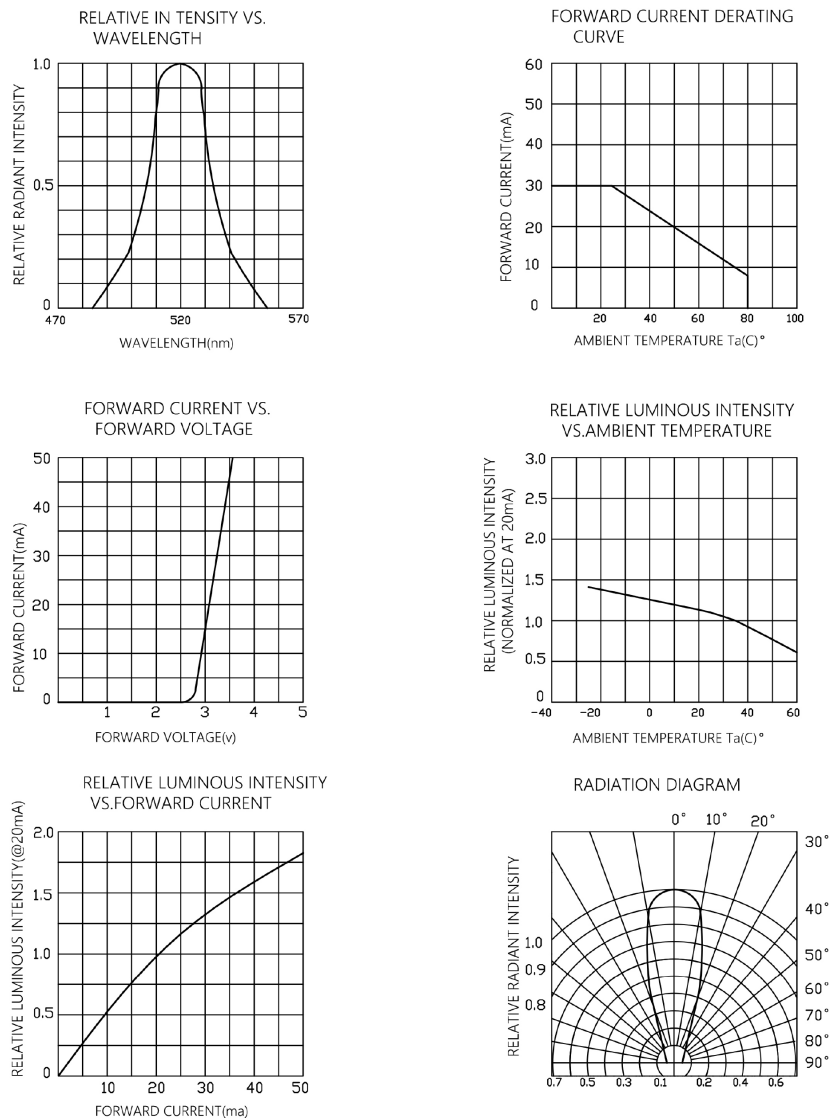
LED ELECTRO-OPTICAL CHARACTERISTIC CURVES (GREEN)

LED ABSOLUTE MAXIMUM RATINGS (YELLOW) (TA=25°C)

parameter	conditions/description	min	typ	max	units
power dissipation [Pd]				60	mW
DC forward current [If]				20	mA
peak forward current [Ifp]	pulse of 1/10 duty and 0.1 ms width			100	mA
reverse voltage [Vr]				5	V

LED ELECTRO-OPTICAL CHARACTERISTICS (YELLOW) (TA=25°C)

parameter	conditions/description	min	typ	max	units
forward voltage [Vf]	at If=20 mA		2.0	2.3	V
luminous intensity [Iv]	at If=20 mA	500	800		mcd
peak wavelength [λp]	at If=20 mA		589		nm
dominant wave length [λd]	at If=20 mA	587	590	593	nm
spectral line half-width [Δλ]	at If=20 mA		30		nm
viewing angle [2θ1/2]	at If=20 mA		30		deg

LED ELECTRO-OPTICAL CHARACTERISTIC CURVES (YELLOW)

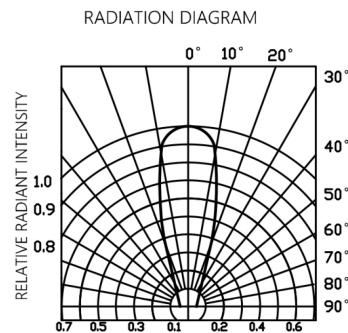
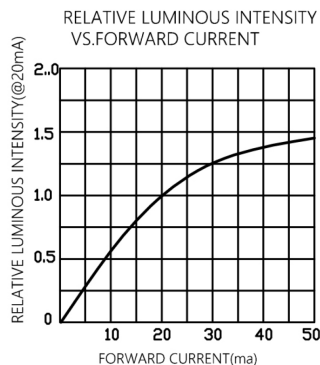
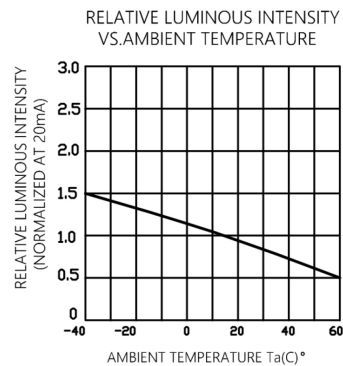
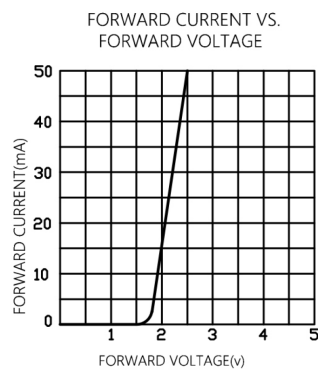
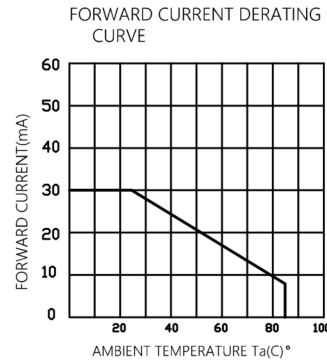
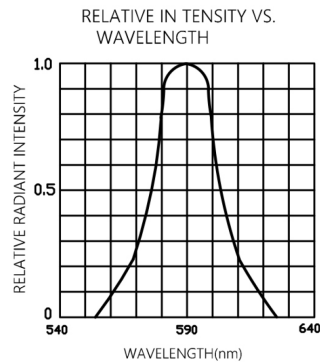

LED ABSOLUTE MAXIMUM RATINGS (RED & BLUE) (TA=25°C)

parameter	conditions/description	min	typ	max	units
power dissipation (Pd)	red			52	mW
	blue			72	mW
DC forward current (If)				20	mA
peak forward current (Ifp)	pulse of 1/10 duty and 0.1 ms width			100	mA
reverse voltage (VR)				5	V

LED ELECTRO-OPTICAL CHARACTERISTICS (RED & BLUE) (TA=25°C)

parameter	conditions/description	min	typ	max	units
forward voltage (Vf)	at If=20 mA		2.0	2.6	V
	red		3.2	3.6	V
luminous intensity (Iv)	at If=20 mA	2,600	3,000		mcd
	red	1,000	1,400		mcd
reverse current (Ir)	at VR=5 V			10	μA
	red			10	μA
peak wave length (λp)	at If=20 mA		622		nm
	red		460		nm
dominant wave length (λd)	at If=20 mA	620		630	nm
	red	455		465	nm
spectral line half-width (Δλ)	at If=20 mA		15		nm
	red		30		nm
viewing angle (2θ1/2)	at If=20 mA		30		deg

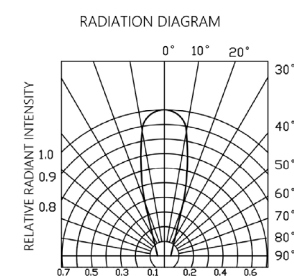
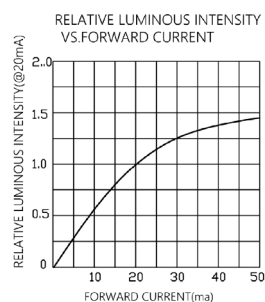
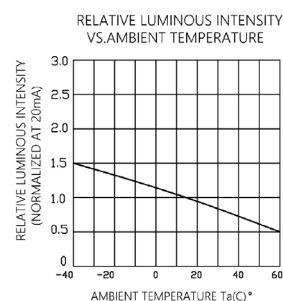
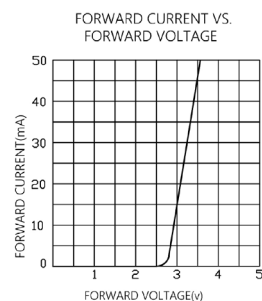
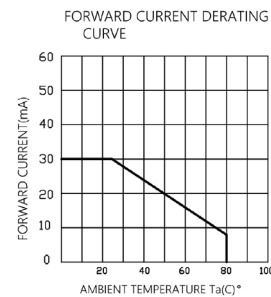
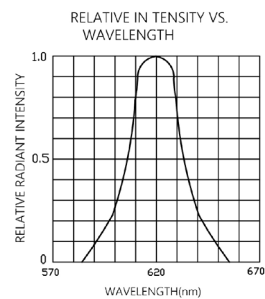
LED ELECTRO-OPTICAL CHARACTERISTIC CURVES (RED)

LED ELECTRO-OPTICAL CHARACTERISTIC (BLUE) (CONTINUED)

RELATIVE INTENSITY VS. WAVELENGTH

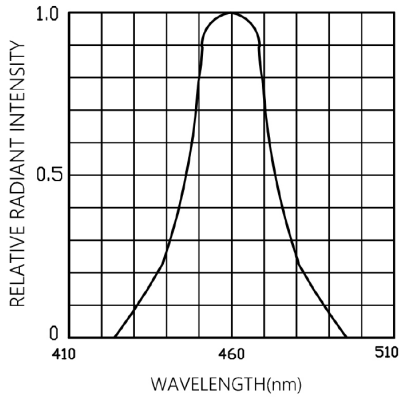

FORWARD CURRENT DERATING CURVE

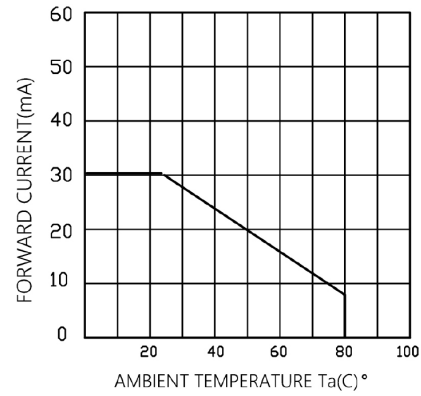

FORWARD CURRENT VS. FORWARD VOLTAGE

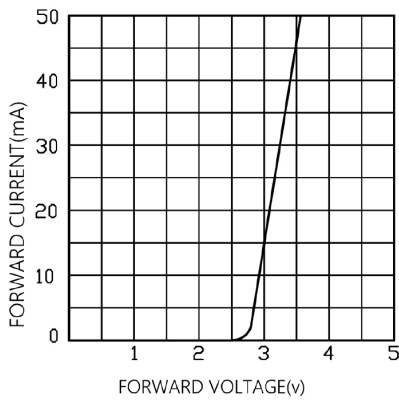

RELATIVE LUMINOUS INTENSITY VS. AMBIENT TEMPERATURE

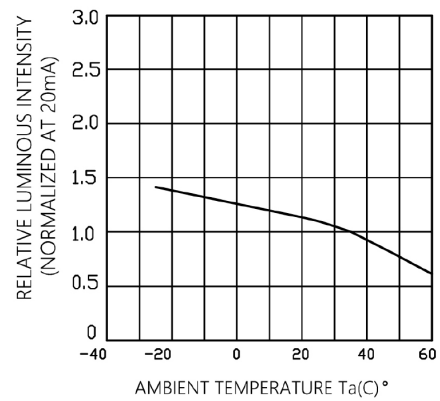

RELATIVE LUMINOUS INTENSITY VS. FORWARD CURRENT

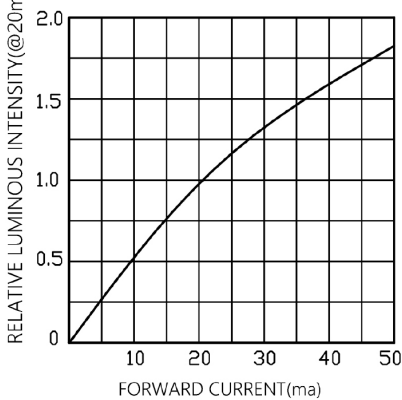

RADIATION DIAGRAM

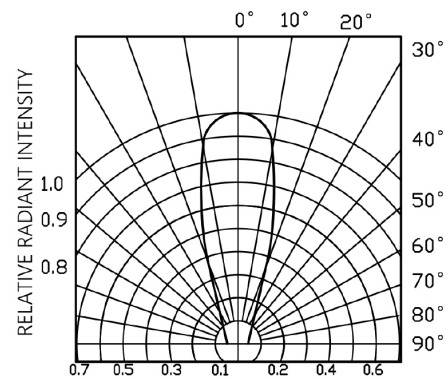

LED ABSOLUTE MAXIMUM RATINGS (RED & GREEN) (TA=25°C)

parameter	conditions/description	min	typ	max	units
power dissipation (Pd)	red green			52 72	mW mW
DC forward current (If)				20	mA
peak forward current (Ifp)	pulse of 1/10 duty and 0.1 ms width			100	mA
reverse voltage (VR)				5	V

LED ELECTRO-OPTICAL CHARACTERISTICS (RED & GREEN) (TA=25°C)

parameter	conditions/description	min	typ	max	units
forward voltage (Vf)	at If=20 mA		2.0 3.2	2.6 3.6	V V
luminous intensity (Iv)	at If=20 mA	2,600 14,500	3,000 15,000		mcd mcd
reverse current (Ir)	at VR=5 V			10 10	µA µA
peak wave length (λp)	at If=20 mA		622 521		nm nm
dominant wave length (λd)	at If=20 mA	620 517		625 525	nm nm
spectral line half-width (Δλ)	at If=20 mA		15 30		nm nm
viewing angle (2θ1/2)	at If=20 mA		30		deg

LED ELECTRO-OPTICAL CHARACTERISTIC CURVES (RED)

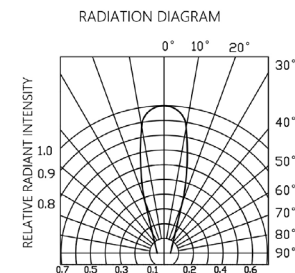
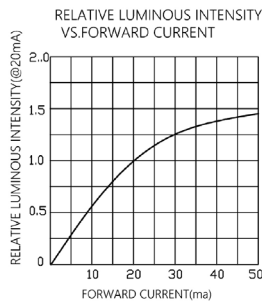
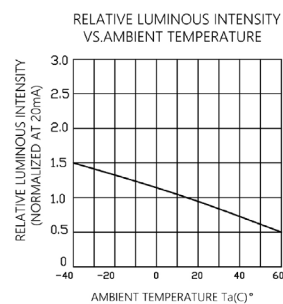
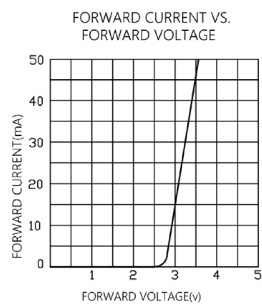
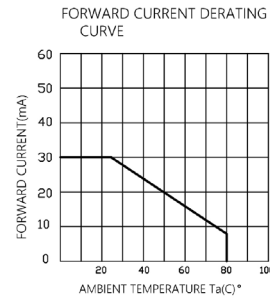
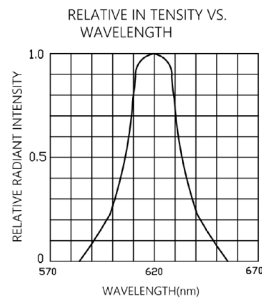

LED ELECTRO-OPTICAL CHARACTERISTIC CURVES (GREEN) (CONTINUED)

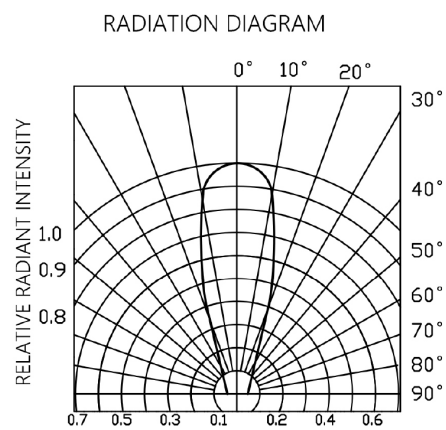
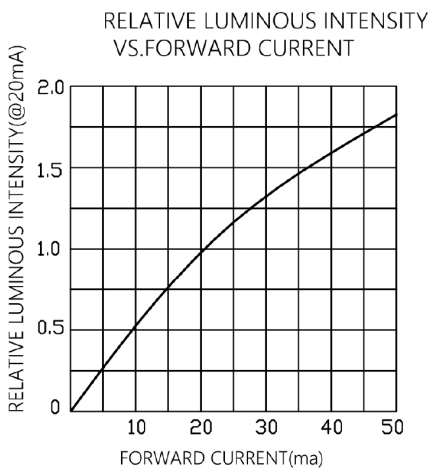
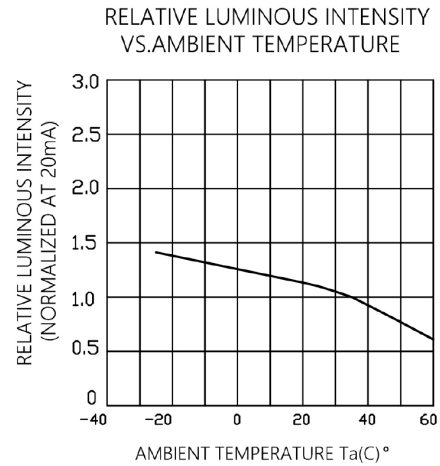
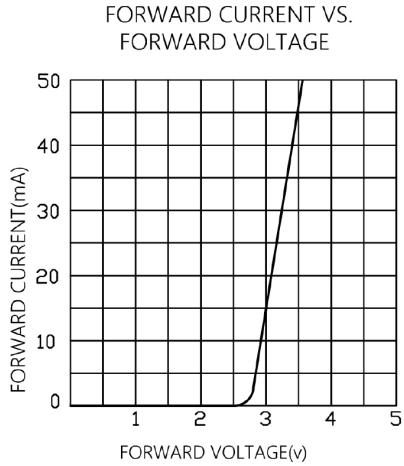
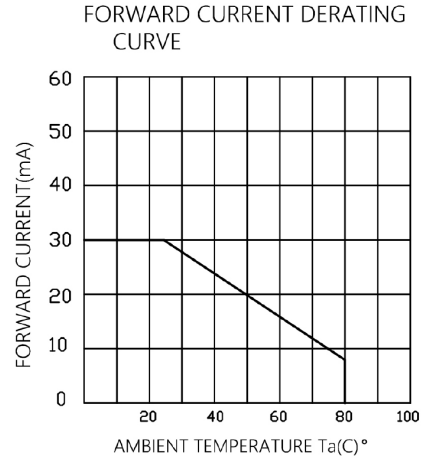
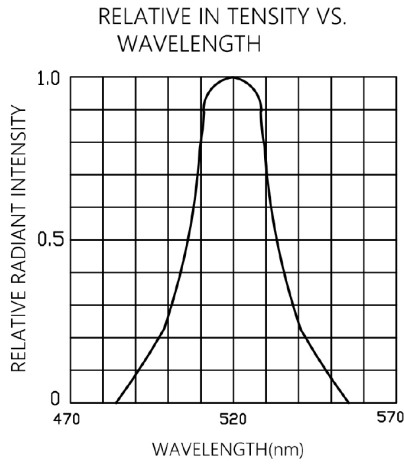

MECHANICAL DRAWING

units: mm
 tolerance: ± 0.4 mm
 unless otherwise noted

ITEM	DESCRIPTION	MATERIAL	PLATING/COLOR
1	terminals	brass	silver
2	base	PA66 (UL94HB)	black
3	contacts	SUS	silver
4	stem	PA66 (UL94HB)	white
5	LED		see part number key

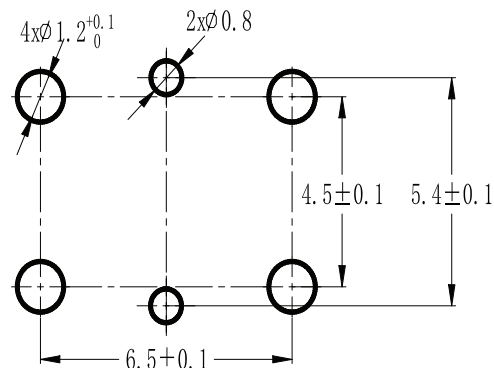
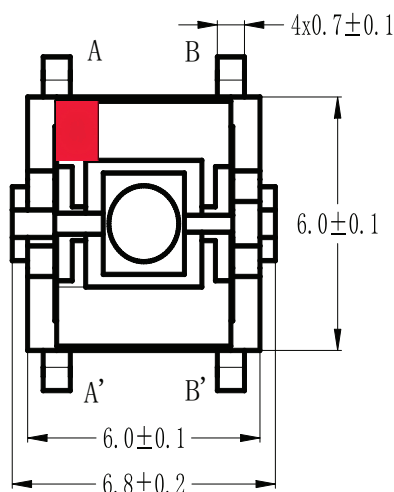
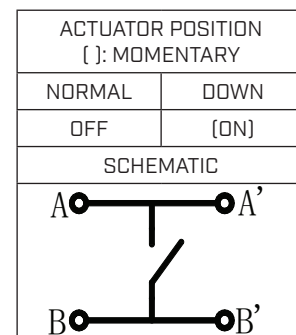
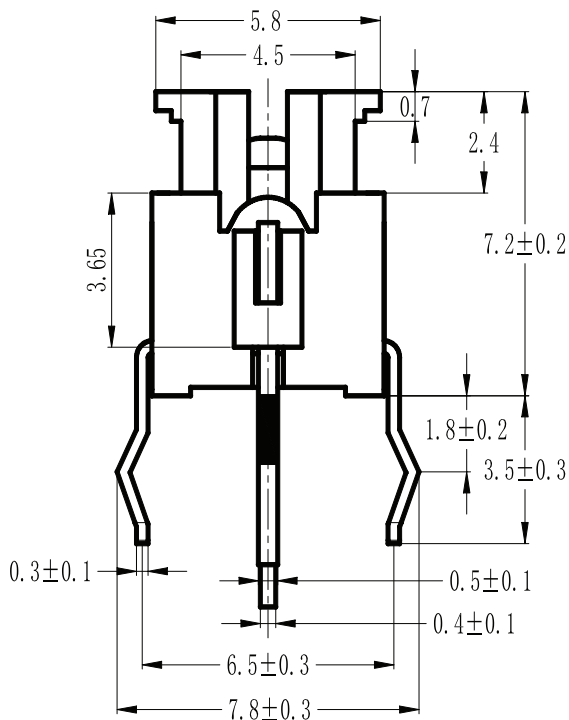
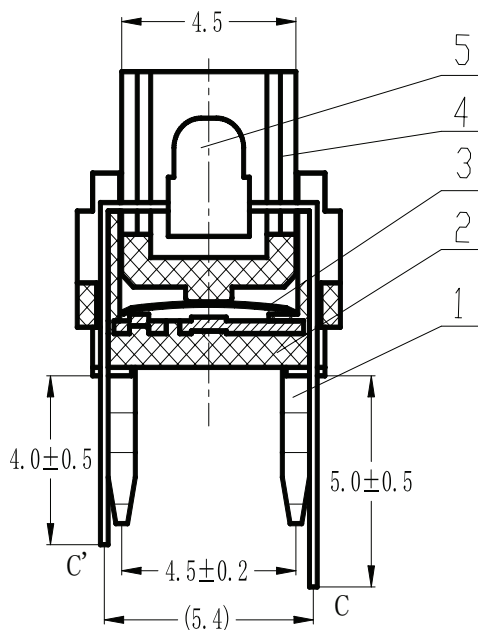

Recommended PCB Layout
Top View

LED Polarity Table			
Model	White, Blue, Red, Green, & Yellow Models	Red-Blue Model	Red-Green Model
Polarity			

PACKAGING

units: mm

Inner Bag Size: 190 x 195 mm
Inner Bag QTY: 1,000 pcs per bag
Carton Size: 350 x 455 x 280 mm
Carton QTY: 32,000 pcs per carton

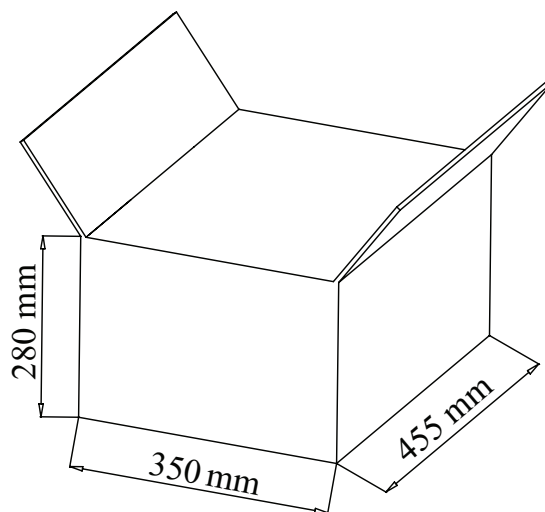
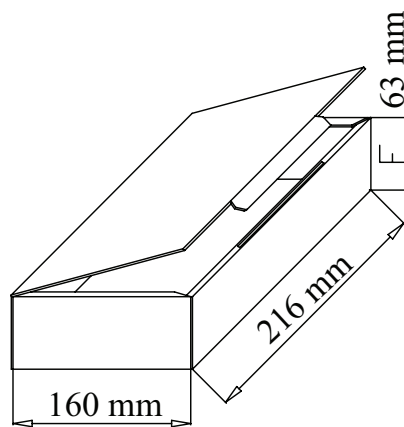
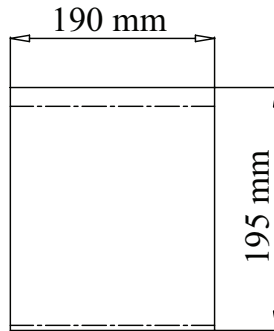

REVISION HISTORY

rev.	description	date
1.0	initial release	06/14/2023

The revision history provided is for informational purposes only and is believed to be accurate.



CUI Devices offers a one (1) year limited warranty. Complete warranty information is listed on our website.

CUI Devices reserves the right to make changes to the product at any time without notice. Information provided by CUI Devices is believed to be accurate and reliable. However, no responsibility is assumed by CUI Devices for its use, nor for any infringements of patents or other rights of third parties which may result from its use.

CUI Devices products are not authorized or warranted for use as critical components in equipment that requires an extremely high level of reliability. A critical component is any component of a life support device or system whose failure to perform can be reasonably expected to cause the failure of the life support device or system, or to affect its safety or effectiveness.

cuidevices.com